

ChronoPlayer

User Guide

V1.1 - February 20, 2019



The ID-AL products are exclusively manufactured by Waves System.

Waves System

7 impasse de La Ville en Bois
44830 BOUAYE
FRANCE

Sales and information: +33 2 40 78 22 44

E-mail: info@id-al.com

Website: www.id-al.com

Technical department: support@wssystem.com

Technical support: For a detailed list of the technical support options, we suggest that you visit our site:
www.id-al.com.

Information in this manual is subject to change without notice and does not represent any commitment from Waves System. The equipment described in this manual is supplied under condition of the terms of license specifying the legal use conditions. This manual may not be reproduced or used, in whole or in part, in any form and by any means, for other use than private, without the written permission from Waves System.

ID-AL is a trademark of Waves System.

CE Marking

The CE marking is found on the nameplate, at the rear side of the device. It certifies the conformance of the device with the low voltage CE Directive, according to the EN 55022 standard, and the Electromagnetic Compatibility Directive 61000-4-x.

Directives

The requirements related to the electromagnetic compatibility and low voltages directive are met.

Safety Instructions

CAUTION! DO NOT EXPOSE TO MOISTURE OR DUST!
Unplug the power supply cable before any servicing!
FOR YOUR SAFETY, PLEASE READ THE USER'S GUIDE CAREFULLY BEFORE OPERATING YOUR PLAYER.

Overview

Proper usage conforming to the product intended purpose involves strict compliance with the instructions given in this manual.

The staff should receive instructions regarding the proper usage of the device.

Only the use of genuine parts ensures perfect safety for the user and correct operation of the device. Moreover, only the accessories mentioned in the technical documentation or explicitly approved by the manufacturer must be used. If accessories or consumable products from other brands are used, the manufacturer cannot stand guarantee for the correct and safe operation of the device.

Damages caused through the use of accessories or consumable products from other brands will not entail right to any benefit under the terms of warranty.

The manufacturer will be liable for the safety, reliability and functioning of the product as long as the assembly, settings, modifications, extensions, and repairs have been carried out by the manufacturer or a company approved by the manufacturer, and if the device is used in accordance with the instructions mentioned in this manual.

The player complies with the technical safety standards in force at the date of print of this manual. All rights reserved for the electrical diagrams, procedures, names, and devices mentioned herein.

Any reproduction of the technical documentation, even partial, without a written authorization from Waves System is prohibited.

General Safety Instructions

This device has been shipped out from our facilities in perfect working condition. In order to preserve these conditions, for safety, and to avoid any risk of accidental bodily injury, the user must imperatively follow the safety instructions and read the “**Caution!**” messages included in this manual.

This device, manufactured by Waves System, has been designed in a way that practically eliminates any risk if it is used in accordance with its intended purpose. Nevertheless, for the sake of safety, we would like to draw your attention to the following instructions:

When using the device, comply with all local rules and regulations in force. Any modification or conversion of the device automatically entails loss of the certification. The operation of a modified device is liable to a penalty. In the interests of occupational safety, the operator and the user are held responsible for complying with the regulations.

Keep the original packing for a possible product reshipment. Also ensure that the packing material is kept out of the reach of children. Only this original packing ensures optimal protection for the product during transportation. If a product reshipment appears to be necessary during the guarantee period, Waves System is not liable for any ensuing damages arising during the transportation and attributable to a defective packing.

This device should be used only by persons whose training or knowledge ensures proper handling.

Before every use, the operator must check that the device is in perfect working condition.

This product must not be used in places where there is a potential explosion risk. Besides, it must neither be used in an environment favoring combustion nor in a humid or excessively hot or cold location.

The device must be installed in a dry and dust-free area. Do not install the device directly against a wall.

Safety Instructions against Risks Due to Electric Currents

The device must be connected to a grounded AC power outlet or a European standard outlet installed as per good professional practices.

Before connecting the device, check that the mains voltage and frequency match the specifications indicated on the mains adapter.

Before powering, check that the device and cables are not damaged. Damaged cables and connections must immediately be replaced.

Never allow the power cords to come in contact with other cables. Handle the mains adapter cable as well as all other cables connected to the mains with extreme care.

Always connect the power cord to the device first, then to the mains. The power outlet must remain accessible after the installation.

Check the device and its mains adapter cable from time to time. Disconnect the device from the mains when it is no longer used or for the purpose of maintenance.

Handle the power cord by using only the plug. Never remove the plug by pulling the power cord.

Electrical connections, repairs, and maintenance must be carried out by qualified personnel.

Do not switch the device on or off within a short period of time as this reduces its lifespan.

Terms of Use

This product has been designed for indoor use only.

If this device has been exposed to very high temperature fluctuations (e.g.: after transportation), do not connect it immediately. The condensation formed inside the device could damage it. Allow the device to reach ambient temperature before connecting it.

Do not shake the device. Avoid sudden movements during its installation or handling.

When selecting the spot for installation of the player, ensure that it is not exposed to a high source of heat, moisture, or dust. There should not be any cables lying around as they might jeopardize your and others' safety.

Delivery Details

ChronoPlayer
12V mains adapter
Infrared remote control

Table of Contents

1	Introduction.....	7
2	Features.....	8
3	Installation.....	9
3.1	Connection of the Inputs.....	10
4	Storage Device Preparation and Update.....	12
4.1	Storage Device Initial Preparation.....	12
4.2	Update of the Storage Device Contents.....	12
5	Control of the ChronoPlayer with the Folders and the Files.....	13
5.1	Organization of the Folders.....	13
5.1.1	[Jxxx] - Jump to the Folder xxx at the End of the Playback of the Folder.....	15
5.1.2	[RET] - Return to the Previous Folder at the End of the Playback of the Folder.....	16
5.1.3	[SEQ] or [RND] - Sequential or Random Playback Mode.....	16
5.1.4	[V+xx] or [V-xx] – Relative Volume of the Folder.....	16
5.1.5	[NT] – Disable the Command Events during the Playback of the Folder.....	17
5.1.6	[RSxxx] - Send Bytes onto the RS-232 Output.....	17
5.1.7	[WHL] - Play the Folder while the Assigned Input Combination Remains Activated.....	19
5.1.8	[NXTxxx] - Play the Next xxx Audio Files each Time the Folder is Played.....	19
5.2	Organization of the Files inside the Folders.....	20
5.2.1	[Jxxx] - Jump to the Folder xxx at the End of the Playback of the File.....	21
5.2.2	[NT] - Disable the Command Events during the Playback of the File.....	22
5.2.3	[RSxxx] - Send Bytes onto the RS-232 Output.....	22
5.2.4	[V+xx] or [V-xx] - Relative Volume of the File.....	22
6	Control of the ChronoPlayer with a Timestamped Programming (Scheduler).....	23
6.1	Introduction.....	23
6.2	Principle.....	23
6.3	Creation of a Timestamped Programming File.....	25
6.4	Application of a Timestamped Programming to the Player.....	25
7	LCD Display and Clickable Knob.....	26
7.1	Current State of the Player.....	26
7.2	Playback Control Command (PLAY/STOP).....	27
7.3	Main Volume Control Using the Knob.....	27
7.4	Setup of the Player Clock Parameters.....	27
8	Main Volume Control.....	30
8.1	Introduction.....	30
8.2	Modification of the Main Volume.....	31
9	Configuration File.....	32
9.1	Assign a Device Number - #ID:xxx.....	33
9.2	Volume Setting - #VOLUME:xx.....	33
9.3	Configuration of the Baud Rate of the RS-232 Serial Link - #BAUDRATE:xxxxx.....	33
9.4	Monitoring of the Player through the RS-232 Serial Link - #RS_MONITORING:x.....	34
9.5	Choice of the Folder to Play on Startup - #BOOT:xxx.....	35
9.6	Assign Specific Commands to the Inputs - #INPUTxx:cmd.....	35
9.7	Assign Specific Commands to the Special Buttons of the Infrared Remote Control - #BUTTONx:cmd.....	36
9.8	Example of a Configuration File.....	37
10	RS-232 Serial Link Protocol.....	38
10.1	Reception Protocol.....	38
10.1.1	Byte 1 (Status) 1xxxxxxb.....	38
10.1.2	Byte 2 (Command) 0xxxxxxb + Byte 3 (Data) 0xxxxxxb.....	39
10.2	Transmission Protocol - Monitoring.....	41
11	Firmware Update.....	44
Appendix A	Characteristics.....	45
A.I	Interfacing and Connectivity.....	45
A.II	Audio File Formats Supported.....	45
A.III	Other File Formats Supported.....	45

A.IV Storage Devices.....	45
A.V Built-in Clock.....	45
A.VI Power Supply.....	45
A.VII Consumption (12 V supplied).....	46
A.VIII Temperatures.....	46
A.IX Size.....	46
A.X Weight.....	46
Appendix B Infrared Remote Control.....	47
Appendix C Built-in Clock.....	48
C.I Principle.....	48
C.II Built-in Clock Setup.....	48
C.III Clock Setup.....	49

1 Introduction

The ChronoPlayer is a standalone audio player supporting WAV and MP3 audio files stored on an SD/SDHC card or a USB flash drive. Files are played automatically according to an "AutoPlay" setting, a timestamped programming, or a triggering by external events (dry-contact inputs, RS-232 serial commands, etc.).

The ChronoPlayer aims at playing musics, sounds, or messages in various environments such as schools, museums, exhibitions, showrooms, stores, attraction parks, touristic places, or any other public spaces.

2 Features

- Interactivity:
 - Electrical contacts: 8 inputs that can be combined to trigger the playback of up to 255 folders through sensors, push-buttons, relays, etc.
 - Commands through the RS-232 serial link. A simple protocol is used to send instructions to the player.
 - Infrared sensor usable with a remote control.
- Timestamped programming: The built-in clock coupled to the Scheduler feature of the ChronoPlayer is used to timetable the music playback, to stop or restart the playback at a specific time and day (defined within the Scheduler).
- AutoPlay: This feature makes it possible to automatically start playback upon power-on. This feature is configurable and can be disabled.
- Playback behavior: The audio files stored on an SD memory card or a USB flash drive can be organized in a particular way that defines the playback rules with the names assigned to the files and the folders. This smart programming allows a wide flexibility of use.
- A line-level stereo audio output on a standard RCA connector.
- Power supply: A 12-V mains adapter is required. The player is protected against polarity reversal and against the use, by mistake, of an alternating-current power supply instead of the provided DC power supply. **Caution!** The player supports a power supply voltage between 10 V and 15 V. Beyond this voltage range, the player can be damaged. The input power supply is transferred to the RS-232 connector (pluggable terminal block) to supply the connected accessories.

A 500-mA (6-W) power supply is adequate to run the player. If you use a PSU of a lower power, you may get a very poor sound and also a PSU overheating till broken down.
- RS-232 serial link: The ChronoPlayer can be controlled by a PLC, a computer, or a remote control using a serial link. The ChronoPlayer receives data on its Rx input and sends data on its Tx output. The serial-link protocol of the ChronoPlayer is described in this manual.

3 Installation

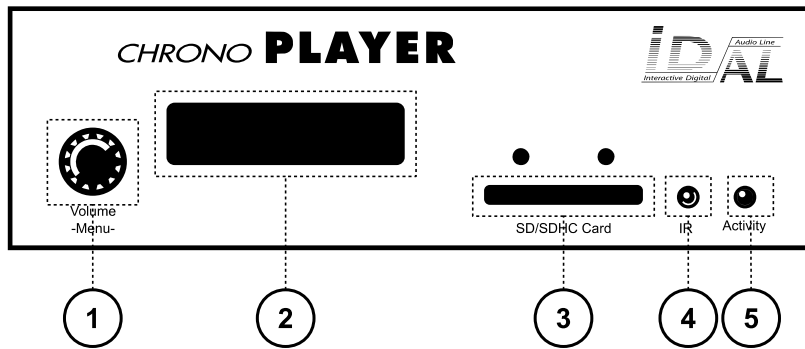

1. Clickable knob for volume control and the setup menu
2. LCD display (player status and settings)
3. SD/SDHC memory card slot
4. Infrared sensor
5. Activity LED

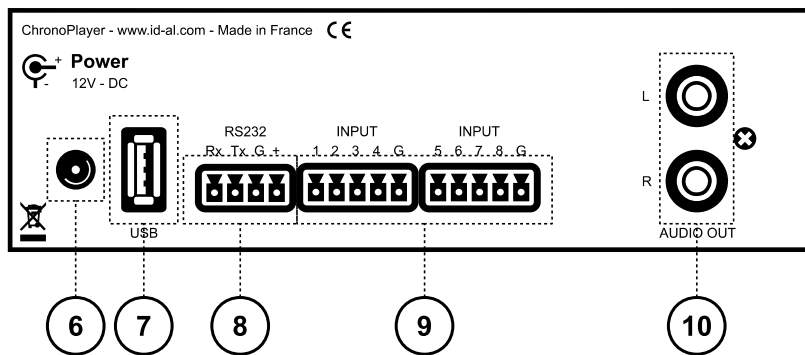

6. Power supply connector of the player
7. USB host receptacle for USB flash drive
8. RS-232 serial link
9. Dry-contact inputs
10. Line-level stereo audio output

First use: The ChronoPlayer ships with default factory settings, and it is ready to operate when a prepared media is inserted in (see the chapter Control of the ChronoPlayer with the Folders and the Files).

Caution! Before inserting a storage device (SD card or USB flash drive), it is absolutely necessary to power off the player.

1. Prepare and insert a quality SD memory card or a USB flash drive.

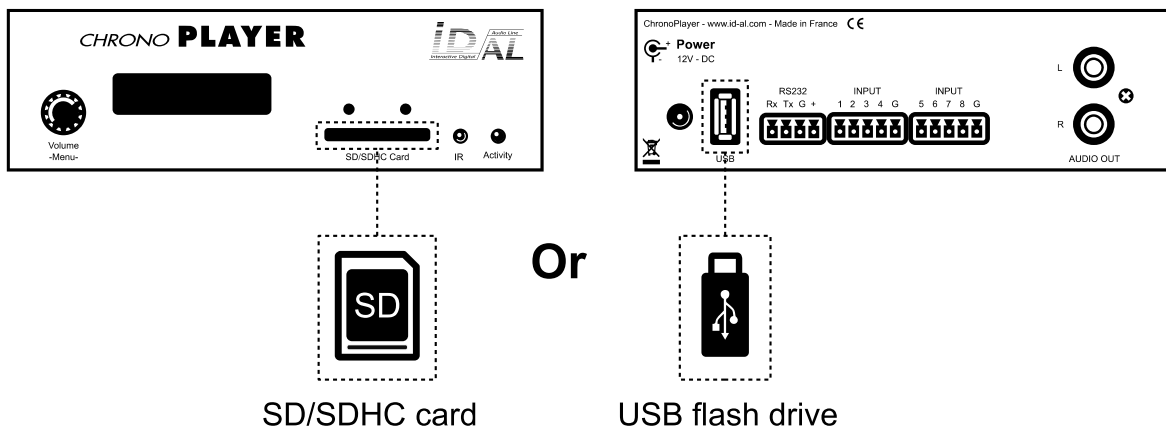

- With an SD card: Choose a quality model. Insert it into the slot to the stop without forcing. To remove it, gently push on the memory card to unlock it.
- With a USB flash drive: Choose a quality model. Plug the USB flash drive into the USB receptacle of the player.

Note: If both an SD card and a USB flash drive are connected, the SD card has the priority, and the USB flash drive is not used by the player.

The SD cards or the USB flash drives used with the ChronoPlayer need to be properly prepared. For more information regarding the preparation of the storage device, see the chapter Storage Device Preparation and Update.

2. Connect speakers or a sound system to the audio output and switch the player on thanks to the PSU.

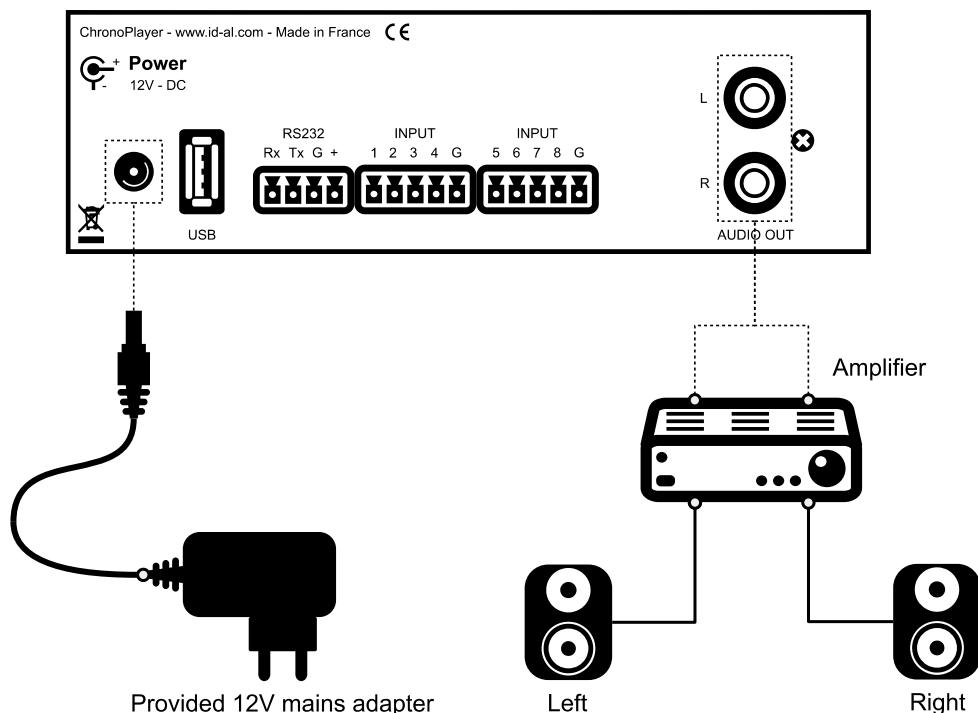

Power Supply Unit: It is recommended to use the mains adapter provided with the player. If another PSU or a battery is used, the specified voltage range must be respected (see the chapter Characteristics). The power consumption depends on the power level of the amplifier.

3.1 Connection of the Inputs

The 8 inputs are used to trigger the playback of folders. An input is activated if it is connected to the ground of the player. The states of all the inputs are combined to form a binary code identifying the folder to play. Triggering devices can be connected to these inputs in one of two ways:

- Up to 8 triggering devices directly connected to the player inputs. In that case, the associated folders are 001, 002, 004, 008, 016, 032, 064, and 128.
- Up to 255 triggering devices connected to the player inputs through a circuit encoding their ID. In that case, the associated folders are 001 to 255. Such an encoding circuit can be made out of diodes. An optional extension board interfacing up to 15 triggering devices to the player inputs is available.

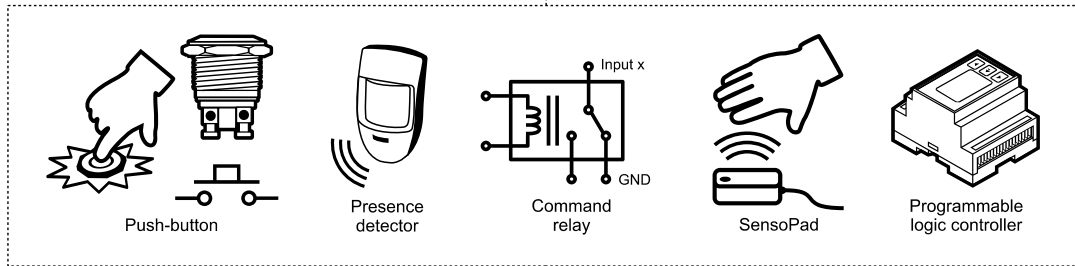
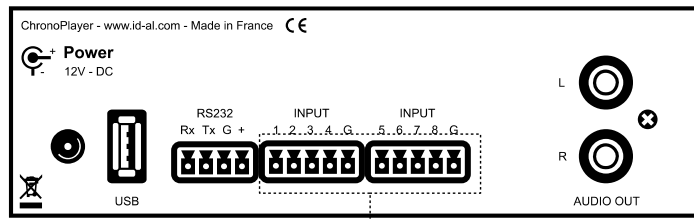

Figure 1: Examples of triggering devices on the dry-contact inputs

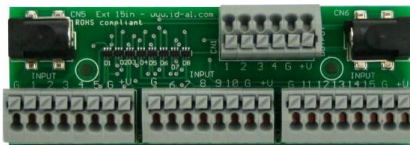

Figure 2: Optional extension board

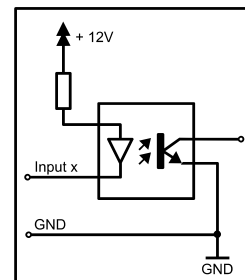
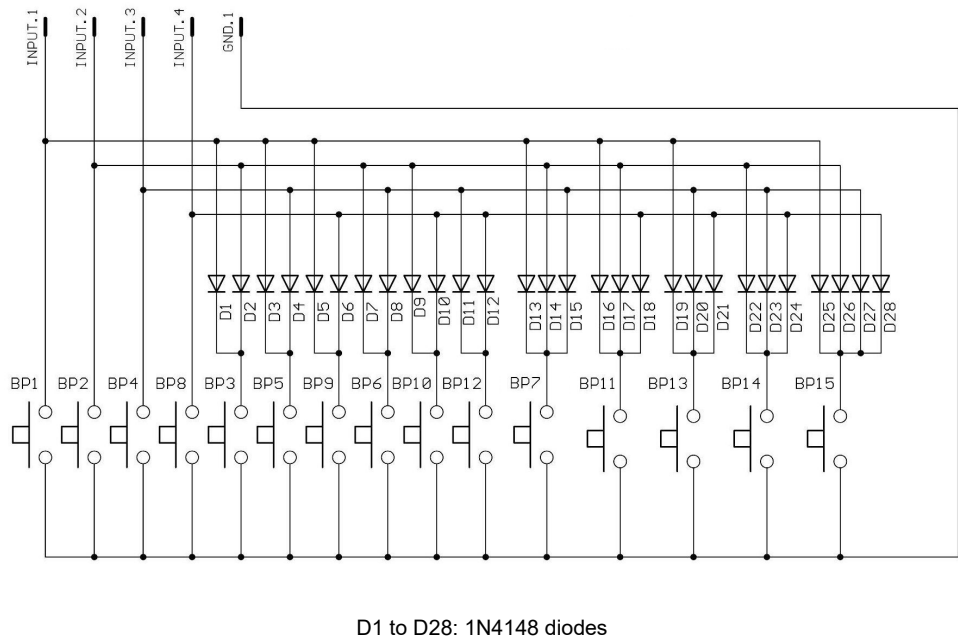

Figure 3: Internal schematic of a player input

Button	Folder	Input			
		1	2	3	4
BP1	001	•			
BP2	002		•		
BP3	003	•	•		
BP4	004			•	
BP5	005	•		•	
BP6	006		•	•	
BP7	007	•	•	•	
BP8	008				•
BP9	009	•			•
BP10	010		•		•
BP11	011	•	•	•	
BP12	012			•	•
BP13	013	•		•	•
BP14	014		•	•	•
BP15	015	•	•	•	•



D1 to D28: 1N4148 diodes

15 push-buttons mapped to 4 inputs

4 Storage Device Preparation and Update

In order to work, the ChronoPlayer needs either an SD/SDHC card or a USB flash drive containing all the required data, mainly numbered folders and audio files, as well as optional files such as a Scheduler timestamped programming file, the setup file `config.txt`, or the `serial.txt` file containing the byte frames to transmit on the RS-232 serial output.

4.1 Storage Device Initial Preparation

It is highly recommended to initially format the storage device (even if it is brand new) using FAT or FAT32 (FAT32 from 512 MiB).

Note: The other file systems (NTFS, exFAT, EXT, HFS, HFS+, etc.) are not compatible with the ChronoPlayer.

Important: The SDXC cards (which are most of the time larger than 32 GiB) are not supported by the ChronoPlayer.

The latest versions of Windows do not allow to format large storage devices (> 32 GiB) using FAT32. In that case, a formatting tool from a third party is required. Such tools can easily be found on the Internet, even free of charge for some of them.

Important: With an Apple computer running OS X, the hidden files generated by this system when preparing or modifying the storage device must be deleted. More information about this procedure is available in the FAQ on the support page of the ChronoPlayer: www.id-al.com.

4.2 Update of the Storage Device Contents

The structure of the contents on the storage device is explained in the chapter Control of the ChronoPlayer with the Folders and the Files. The ChronoPlayer support page (www.id-al.com) provides test contents that can be used as an example for the first startup of the player.

The content update of the storage device has to be performed as follows:

1. Switch off the player.
2. Remove the storage device (SD card or USB flash drive) from the player.
3. Connect the storage device to a computer.
4. Copy, rename, or delete the necessary files or folders by following the instructions in the chapter Control of the ChronoPlayer with the Folders and the Files or in any other chapter about the player contents.
5. Remove the storage device by using the eject procedure of the computer operating system.
6. Insert the storage device in the player.
7. Switch on the player.

5 Control of the ChronoPlayer with the Folders and the Files

The naming of the folders and the files define the playback rules. The folders and the files must be named and copied according to a specific organization described in the following chapters.

5.1 Organization of the Folders

Only one folder level is allowed at the root of the storage device. The folder names are composed of 3 digits (from 000 to 999) followed by optional parameters and an optional arbitrary name.

You must not use special or accented characters.

Example

Folder Name
001
003 [J003]
008 folder name
247 [V+02][SEQ] my folder

The first 3 digits represent the folder number, and are therefore the main part of its name.

The folders are numbered from 000 to 999.

Example

Folder No.	Description
000	Folder number 0 - "AutoPlay" folder, which is automatically played upon power-on.
001	Folder number 1.
034	Folder number 34.

The folder number identifies the folder to be played on startup, or as the target of a jump, or in case of an input triggering or a scheduled triggering. You can use any number between 000 and 999.

Important: The 8 input contacts allow the triggering of the folder with the number corresponding to the binary code formed by the states of all the inputs, from 001 to 255. It is possible to reassign the first 15 input codes, either to the playback of another folder, or to another command, with the file `config.txt` (see the chapter: Configuration File).

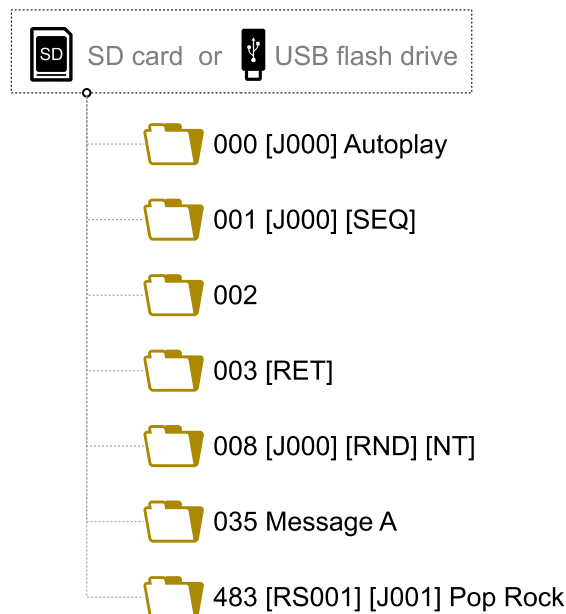

Table 1: Correlation between the inputs and the folder numbers

Folder No.	Input No.							
	1	2	3	4	5	6	7	8
	Corresponding Binary Values							
	1	2	4	8	16	32	64	128
001	•							
002		•						
003	•	•						
004			•					
005	•		•					
006		•	•					
007	•	•	•					
008				•				
009	•			•				
010		•		•				
011	•	•		•				
012			•	•				
013	•		•	•				
014		•	•	•				
015	•	•	•	•				
016					•			
017	•				•			
...								
031	•	•	•	•	•			
032						•		
033	•					•		
...								
063	•	•	•	•	•	•		
064							•	
065	•						•	
...								
127	•	•	•	•	•	•	•	
128								•
129	•							•
...								
254		•	•	•	•	•	•	•
255	•	•	•	•	•	•	•	•

Special case: The folder 000 is the folder played by default on startup, if present. If this folder is missing, the player switches to the STOP state.

Note: The folder that is played by default on startup can be modified in the configuration file (see the chapter: Configuration File).

To change the behavior of the player, optional parameters can be added to the folder names. These parameters have to be enclosed between square brackets ([and]). Several parameters can be added to the same folder name.

Table 2: Optional tags pertaining to the names of the folders

Tag	Description
[Jxxx]	Jump to another folder after the playback of the folder, or play in a loop (i.e. jump to the same folder at end of playback).
[RET]	Return to the previous folder after the playback of the folder.
[RND] or [SEQ]	Random or sequential playback mode of the folder.
[V+xx] or [V-xx]	Relative volume setting of the folder.
[NT]	Disable the command events.
[RSxxx]	Send an RS-232 frame.
[WHL]	Play the folder while the assigned input combination remains activated.
[NXTxxx]	Play a specific number of audio files from the folder.

Note: If no optional parameters are indicated, the player plays randomly the complete folder, and then stops. The playback of the folder can be interrupted by a triggering event.

5.1.1 [Jxxx] - Jump to the Folder xxx at the End of the Playback of the Folder

This tag defines the behavior at the end of the playback of the folder. It indicates the 3-digit number (xxx from 000 to 999) of the next folder to play, which can also be the number of the folder itself in order to play it in a loop. By default, if this tag is missing, the playback stops at the end of the folder.

Example

Folder Name	Action Performed by the Tag
001 [J002]	Jump to folder 002 after playing folder 001.
003 [J003]	Jump to folder 003 after playing folder 003 -> create a loop of the 003 folder.
008 [J023]	Jump to folder 023 after playing folder 008.
458 [J999]	Jump to folder 999 after playing folder 458.

To play in a loop some audio files on startup, the folder 000 must be used and tagged with [J000] (default value that can be modified through the `config.txt` file (see the chapter Configuration File)).

Example: 000[J000]

- If the destination folder does not exist, the playback is stopped.
- An empty target folder is not a special case. Its playback is just instantaneous since there are no files to play. This means that the tags of an empty target folder are applied normally if any. The playback stops in such a folder unless it has [Jxxx] or [RET] tags.

5.1.2 [RET] - Return to the Previous Folder at the End of the Playback of the Folder

During the playback of a folder, if an event or a tag instructs to play another folder tagged with [RET], then the player jumps to the new folder. At the end of the playback of this new folder, the player jumps back to the initial folder.

This function can be used to resume the playback of a folder interrupted by the playback of a message triggered by an event.

Example

Folder Name	Action Performed by the Tag
001 [J100]	After the folder 001 playback, jump to the folder 100.
002 [J100]	After the folder 002 playback, jump to the folder 100.
100 [RET]	After the folder 100 playback, return to the previous folder (001 or 002).

In the above example, after the playback of the folder 001 or 002, the folder 100 is played, then the player jumps back to the initial folder (001 or 002).

Note: The [RET] tag has only one level of return, i.e. the target folder is always the previously played folder, whatever the number of folders tagged with [RET] played in a row.

5.1.3 [SEQ] or [RND] - Sequential or Random Playback Mode

By default, without this parameter, the folder is played in random mode.

- [SEQ]: playback of the numbered files (from 001 to 999) of the folder, in ascending order (see the chapter Organization of the Files inside the Folders).
- [RND]: playback in a random order.

Example

Folder Name	Action Performed by the Tag
001[SEQ]	Play the folder 001 in sequential mode, then stop.
002[RND][J002]	Play the folder 002 in random mode and in a loop.
003[J001]	Play the folder 003 in random mode, then jump to the folder 001.

Caution! With [SEQ], the files that are not numbered are ignored. Therefore, a folder without any numbered file is always considered as empty.

5.1.4 [V+xx] or [V-xx] – Relative Volume of the Folder

This function can be used to play folders (e.g. containing messages) more or less loud than the other folders.

The xx parameter of the tag is the volume of the folder relatively to the main volume (see the Table 6: Volume (dB) against the selected setting value). It is expressed in volume steps. It is always written with 2 digits (example: 01, 32, 64), ranging from 00 to 64.

Example

Folder Name	Action Performed by the Tag
001 [V+05]	Increase the volume level by 5 steps during the folder playback.
001 [V-03]	Decrease the volume level by 3 steps during the folder playback.

At the end of the playback of the folder, the volume level goes back to its previous level.

Note: If the resulting volume is out of the allowed volume range of the player, then it is limited to the minimum or maximum value.

5.1.5 [NT] – Disable the Command Events during the Playback of the Folder

The playback of the folders with this tag cannot be interrupted, and it ignores the instructions received, according to the table below:

Table 3: Commands blocked with the [NT] tag

Command	Source				
	Inputs	RS-232	Scheduler	Knob Click	IR Remote Control
Folder change request	•	•	•	N/A	
Other	•				

Note: Without this option, the playback of the tagged folder can be interrupted at any time by a command event (input, RS-232, Scheduler, etc.).

Example

Folder Name	Action Performed by the Tag
001 [NT]	The instructions received are ignored during the playback of the folder 001.

In that case, a command on one of the input contacts, or through RS-232 or other is ignored, and the playback of the current folder is not stopped.

5.1.6 [RSxxx] - Send Bytes onto the RS-232 Output

When the folder is called, a list of bytes is transferred by the serial link in order to control other devices (another player, a switching grid, a video projector, etc.). The bytes to send are included in a text file that is especially created for this purpose.

Table 4: Default settings for the RS-232 link

Baud Rate (bauds)	Start Bit(s)	Data Bit(s)	Parity Bit(s)	Stop Bit(s)	Handshake
19200	1	8	0	1	None

Note: The baud rate is configurable in the settings file of the player `config.txt` (see the chapter: Configuration File).

The xxx parameter of the tag is the number of the frame to send (line ID in the `serial.txt` file). It is always

written with 3 digits (example: 001, 045, 999). It is between 001 and 999.

The file defining the bytes to send must be named `serial.txt`. This file must be located at the root of the storage device (SD card or USB flash drive).

This file is a text file (raw text, without formatting) that can be created with any simple text editor like “Notepad” from Windows, or similar. This file must be saved with the “ANSI” encoding. Do not use special characters.

The file `serial.txt` of RS-232 codes is a text file containing one or several lines. Each of these lines includes a sequence of bytes expressed in hexadecimal (from 00h to FFh) and separated with a space. Only the two characters of the wished hexadecimal value are required.

Each line of this file must start with the following parameter:

`#xxx`: the xxx ID of the line containing the bytes to send related to the xxx of the tag.

[RS002] → line #002 – The tag [RS002] will send the sequence of bytes of the line #002 of the `serial.txt` file.

Example of lines contained in the `serial.txt` file

```
#001:45 85 63 21 78 A5 B2
#002:98 75 21 35 45 98
#100:21 35 45 78 A5 B2
```

It is also possible to append comments to the lines of this file with two slashes (`//` comment).

Example

```
// example file
#001:05 A1 FF E4 // inline comment
#005:45 85 63 21 78 A5 B2
#100:98 75 35 45 98 // my command

// other command
#064: 48 25 Ce 8b

#128:4C 8E D9 5A //
#999:a4 Fc 48 3e 8B
// comment at the end of the file
```

Example to allow the triggering of the playback of the folder 001 of another ChronoPlayer

```
#001:80 01 01
```

Example

Folder Name	Action Performed by the Tag
001[RS001]	Send the bytes of the line #001 of the file <code>serial.txt</code> at the beginning of the playback of the folder 001.
002[RS064]	Send the bytes of the line #064 of the file <code>serial.txt</code> at the beginning of the playback of the folder 064.

Note: When a folder is played in a loop, the RS-232 message defined with the [RSxxx] tag is sent on each loop of the folder.

Example

Folder Name	Action Performed by the Tag
001[J001][RS099]	Playback of the folder 001 in a loop. On each loop of the folder, the message described at line 099 of the file <code>serial.txt</code> is sent on the player's RS-232 output.

5.1.7 [WHL] - Play the Folder while the Assigned Input Combination Remains Activated

This tag allows to play the contents of a folder as long as the corresponding input combination is activated. When the input combination associated with the folder is deactivated, the player applies the folder exit tags. As long as the corresponding input combination is activated, the folder is played in a loop.

Example

Folder Name	Action Performed by the Tag
001[WHL]	The folder 001 is played in a loop while the input combination 1 is activated. When the input combination 1 is deactivated, the player stops.
002[WHL][J045]	The folder 002 is played in a loop while the input combination 2 is activated. When the input combination 2 is deactivated, the player plays the folder 045.
003[WHL][J999]	The folder 003 is played in a loop while the input combination 3 is activated (inputs 1 and 2 activated). When the input combination 3 is deactivated (inputs 1 and 2 deactivated), the player plays the folder 999.

The dry contact inputs of the player are combinatorial. Therefore, any changes of the input combination are taken into account at any time by the player.

Example

Folder Name	Action Performed by the Tag
000[J000]	The folder 000 is played in a loop on startup.
001[WHL][J000]	The folder 001 is played in a loop while the input combination 1 is activated (input 1 alone). If the input 2 is activated in addition to the input 1, this activates the input combination 3, so the player plays the folder 003.
002[WHL][J000]	The folder 002 is played in a loop while the input combination 2 is activated (input 2 alone). If the input 1 is activated in addition to the input 2, this activates the input combination 3, so the player plays the folder 003.
003[WHL][J000]	The folder 003 is played in a loop while the input combination 3 is activated (inputs 1 and 2 activated). If the input 1 is released, the player plays the folder 002. But, if the input 2 is released, the player plays the folder 001.

5.1.8 [NXTxxx] - Play the Next xxx Audio Files each Time the Folder is Played

This setting allows to play xxx audio files contained in the folder. Once xxx files have been played, the player applies the folder exit tags. If the number of files requested by this tag is greater than the number of audio files contained in the folder, the player loops in the folder as long as needed in order to play the exact number of audio files requested.

With this tag, the player memorizes the played audio files, meaning that the audio files already played during a previous passing in the folder are not replayed while not all the audio files of the folder have been played.

The xxx parameter of the tag [NXTxxx] is the number of audio files to play in the folder. It is always written with 3 digits (e.g.: 001, 045, 999). It is between 001 and 999.

Example

Folder Name	Action Performed by the Tag
001[NXT003]	3 audio files are played in the folder 001, then the player stops.
002[NXT001][J000]	1 audio file is played in the folder 002, then the player plays the folder 000.
003[NXT005][RET]	5 audio files are played in the folder 003, then the player plays the last folder called.
004[NXT002][SEQ] [J000]	The next 2 files according to the file numbering are played in the folder 004, then the player plays the folder 000.

5.2 Organization of the Files inside the Folders

Like for the folders, the filenames define the behavior of the playback.

Note: The naming of the files is free if the playback is in random mode. ([RND] option or no option in the folder name). In this case, all the files are played and can be interrupted.

In sequential mode, the files must be numbered. The names are composed of 3 digits (001 to 999) and of the name of your choice. Playback options (tags) can be added as needed, like a blocking of commands or a temporary change of the volume.

Example

001 [J367] my message.mp3
063 [RS020] filename.wav
845 [V+12] my file.mp3
My Song [NT].wav

Two types of audio files can be used:

- WAV audio files (.wav).
- MP3 audio files (.mp3).

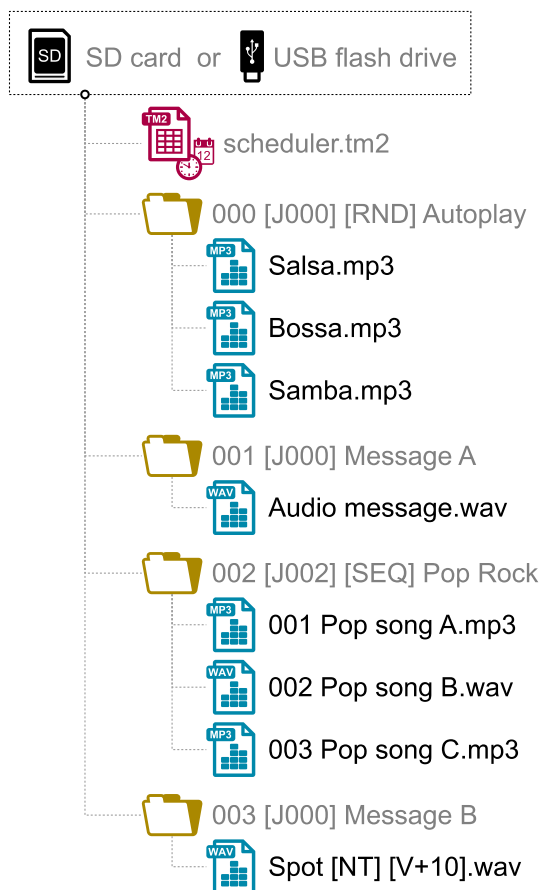

For more information about the audio file formats supported by the player, see the chapter Audio File Formats Supported.

Note: In sequential mode (SEQ), if both numbered and unnumbered files are present, only the numbered files are played. In random mode, all the files are played.

The first 3 digits represent the file number, and are therefore the main part of its name (from 001 to 999).

Example

Filename	File No.
001.mp3	001
063.wav	063

To change the behavior of the player, optional parameters can be added to the filenames. These parameters have to be enclosed between square brackets ([] and []). Several parameters can be added to the same filename.

Table 5: Optional tags pertaining to the filenames

Tag	Description
[Jxxx]	Jump to a folder after the playback of the file.
[V+xx] or [V-xx]	Relative volume setting of the file.
[NT]	Disable the command events.
[RSxxx]	Send an RS-232 frame.

Note: Without any option, the files are played one after another according to the selected mode (random or sequential) and can be interrupted at any time with an external action.

5.2.1 [Jxxx] - Jump to the Folder xxx at the End of the Playback of the File

This tag defines the behavior of the player at the end of the playback of the file. It indicates the 3-digit number (xxx from 000 to 999) of the folder to play after this file.

- If the destination folder does not exist, the playback is stopped.
- An empty target folder is not a special case. Its playback is just instantaneous since there are no files to play. This means that the tags of an empty target folder are applied normally if any. The playback stops in such a folder unless it has [Jxxx] or [RET] tags.

Example

Filename	Action Performed by the Tag
My file [J002].mp3	Jump to the folder 002 after playing the file.
003[J023].mp3	Jump to the folder 023 after playing the file 003.
034[J034].wav	Jump to the folder 034 after playing the file 034. It's not a loop with the file 034 but a jump to the folder 034.

This function allows to watch over a file so that a jump action follows. Several files can designate the same folder as the jump target.

Example

Filename	Action Performed by the Tag
001 [J100].mp3	After playing the file 001, jump to the folder 100.
002 [J100].wav	After playing the file 002, jump to the folder 100.

5.2.2 [NT] - Disable the Command Events during the Playback of the File

This tag behaves like the [NT] tag of the folders, except that it applies during the playback of the file, not during the playback of the folder. See the section: [NT] – Disable the Command Events during the Playback of the Folder.

5.2.3 [RSxxx] - Send Bytes onto the RS-232 Output

This tag behaves like the [RSxxx] tag of the folders, except that it applies at the beginning of the playback of the file, not at the beginning of the playback of the folder. See the section: [RSxxx] - Send Bytes onto the RS-232 Output about the folders.

5.2.4 [V+xx] or [V-xx] - Relative Volume of the File

These tags behave like the [V+xx] and [V-xx] tags of the folders, except that:

- they apply during the playback of the files, not during the playback of the folders,
- the indicated volume is relative to the folder volume, not to the main volume.

See the section: [V+xx] or [V-xx] – Relative Volume of the Folder.

6 Control of the ChronoPlayer with a Timestamped Programming (Scheduler)

6.1 Introduction

The ChronoPlayer can be controlled thanks to a timestamped programming. This feature, named Scheduler, allows to timetable the playback of audio files (messages, spots, musics, sounds) and to stop or resume the playback on accurate date and time.

Note: This feature depends on the clock of the player (see the chapters Built-in Clock and Setup of the Player Clock Parameters).

6.2 Principle

The ChronoPlayer uses its built-in clock to perform scheduled actions. These actions are stored in a timestamped programming file named the Scheduler file.

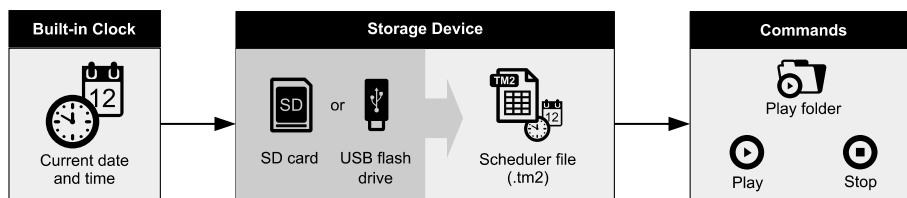

Figure 4: Functioning of the timestamped programming

The timestamped programming file is made of a calendar from January 1, 2016 to December 31, 2037. Each date of the calendar refers to a “day template” containing a set of scheduled actions.

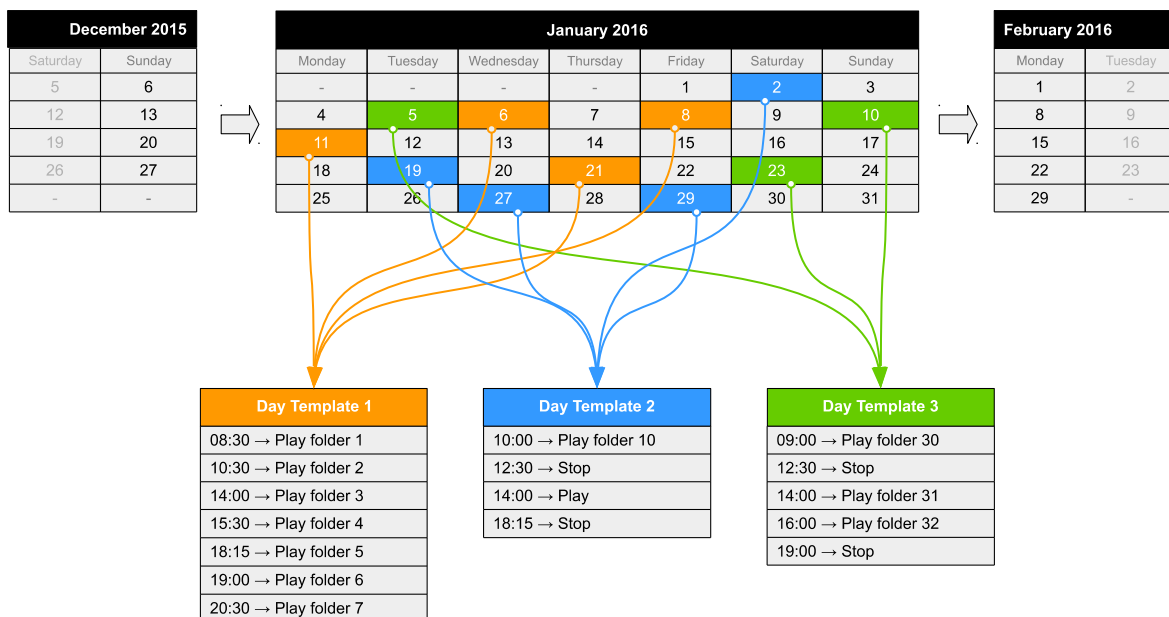

Figure 5: Functioning of the calendar

- Notes:**
- The dates requiring no actions are left empty and do not refer to any day template.
 - If several dates require the exact same set of actions, then the calendar can refer to the same day template for these dates.

A day template contains all the events of a full day, for every minute, from 00:00 till 23:59. These events describe the command (action) to execute and when (precise time).

With the Scheduler feature of the ChronoPlayer:

- A schedule can contain up to 65535 different day templates.
- Within a day template, a different command can be scheduled for each minute.
- An action takes place precisely upon minute change.
- An event can execute a one-time command.

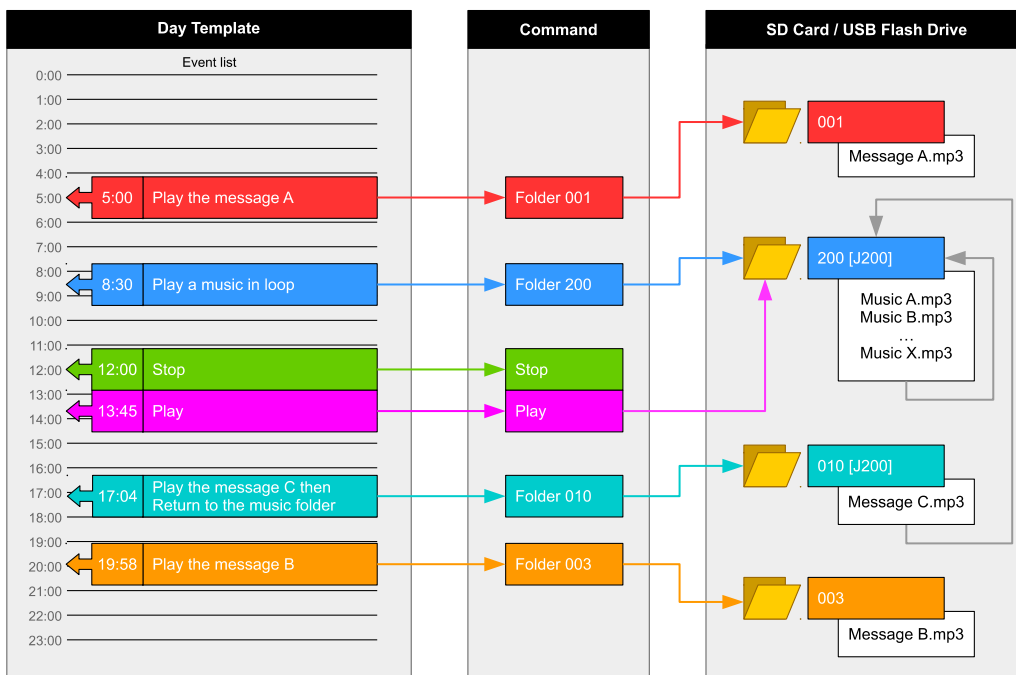

Figure 6: Functioning of a day template

The following commands can be attached to an event:

- **PLAY FOLDER:** launch the playback of a folder containing audio files (up to 1000 folders supported). This command requires the number of the folder to play (3 first digits between 000 and 999). The folder has to be stored in the root folder of the storage device. The way a folder is played depends on the tags appended to its name (loop: xxx[Jxxx], random: xxx[RND], sequential: xxx[SEQ]) (see the chapters Organization of the Folders).
- **PLAY:** launch the playback of the folder in which the player stopped. If no folder playback action predates this command, or if the player stopped because out of a folder, this action is ignored.
- **STOP:** stop the playback within the folder being played.

6.3 Creation of a Timestamped Programming File

The timestamped programming is stored in a Scheduler file. This file is generated by the Scheduler software developed for this purpose. Please check our website for additional information (www.id-al.com support page). The files generated by the Scheduler software are TM2 files with the `.tm2` extension (e.g.: `my programming.tm2`).

Note: Prior to any use of the Scheduler software, carefully read the information related to its prerequisites as well as its user's guide.

6.4 Application of a Timestamped Programming to the Player

Once the Scheduler programming file has been created, copy the programming file `.tm2` into the root folder of the storage device (see the chapter Storage Device Preparation and Update).

7 LCD Display and Clickable Knob

The ChronoPlayer features a user interface composed of an LCD display and a clickable knob named `Volume/-Menu-`. This makes it possible for the user to view the player state, to occasionally control it, or simply to set it up. This chapter explains how to use this user interface.

7.1 Current State of the Player

- **Upon startup, the player displays:**
 - the name of the player,
 - its firmware version.

- **When the playback of an audio file is stopped, the player displays:**
 - the 3-digit number of the folder in which the player is stopped,
 - the total duration of the pending audio file,
 - the full name of the pending audio file. If the filename exceeds the display width, it scrolls from right to left.

- **When the player does not play any audio file or when the playback has been stopped for more than 30 seconds, the player displays:**
 - the date, formatted as year/month/day,
 - the time, formatted as hours:minutes:seconds.

- **During playback, the player displays:**
 - the 3-digit number of the current folder,
 - the remaining time of the current audio file, formatted as hours:minutes:seconds,
 - the full name of the current audio file. If the filename exceeds the display width, it scrolls from right to left.

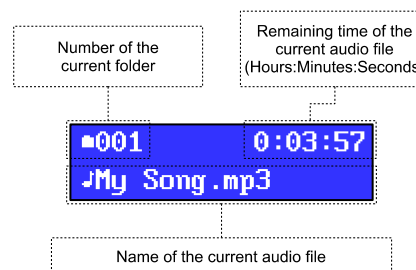
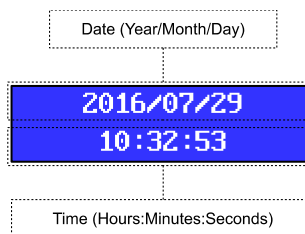
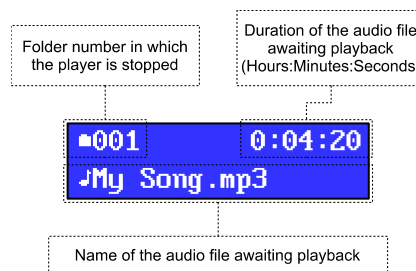
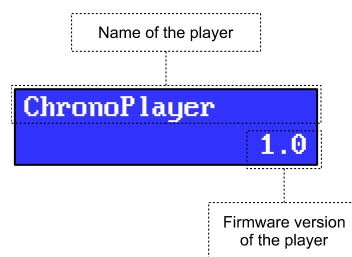

7.2 Playback Control Command (PLAY/STOP)

To restart the playback (PLAY) or to stop it (STOP), briefly (less than 3 seconds) press the `Volume/-Menu-` knob.

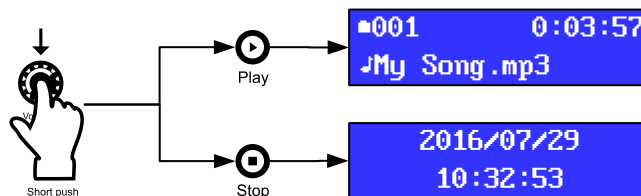

- During the playback, this action triggers a STOP command. The player will then display its current date and time after a few seconds.
- If no audio file is being played, the folder in which the player is stopped will be played.

Note: If no playback operation has preceded this command, or if the player has stopped after exiting a folder, then this command is ignored.

7.3 Main Volume Control Using the Knob

To change the volume, turn the `Volume/-Menu-` knob:

- counterclockwise to decrease the volume,
- clockwise to increase the volume.

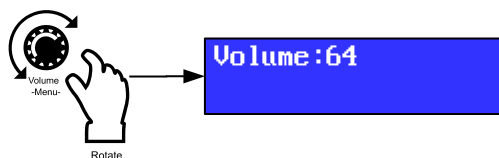

For more information regarding the main volume setup methods, see the chapter Main Volume Control.

7.4 Setup of the Player Clock Parameters

To modify the date and time, as well as the reference time zone of the player, perform a long push (more than 3 seconds) on the `Volume/-Menu-` knob in order to access the setup menu.



The first line displays the name of the time zone setup sub-menu. The second line displays the active time zone rule: either a geographical rule (i.e. a country, with a region if any), or a constant UTC-relative offset.

To browse the setup menu, turn the knob, and validate with a short push on the knob. Once a menu item has been selected, the parameters are edited sequentially. The focused parameter blinks. To change the displayed value of the parameter, turn the knob, and validate with a short push on the knob.

For more information about the clock of the player, see the chapter Built-in Clock.

1. Time zone setup:

- Select the **Time zone:** menu item with the knob in order to edit the reference time zone parameters of the player.

- The player displays **World area/UTC:**. Select and validate a world area among the proposed list, or the UTC setup mode.

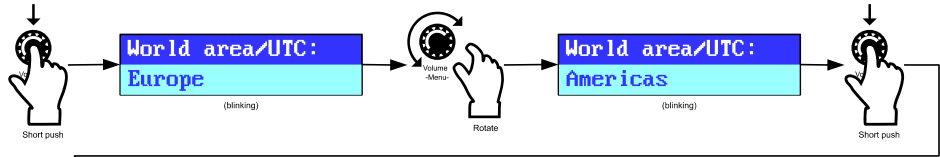

- The player displays **Country:**. Select and validate a country among the proposed list, or a UTC-relative offset.

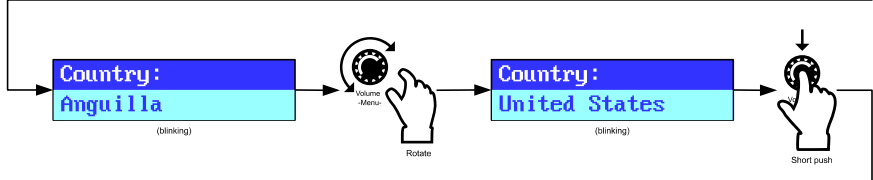

- If the selected country has several regional rules, the player displays **Region:**. Select and validate a region among the proposed list.

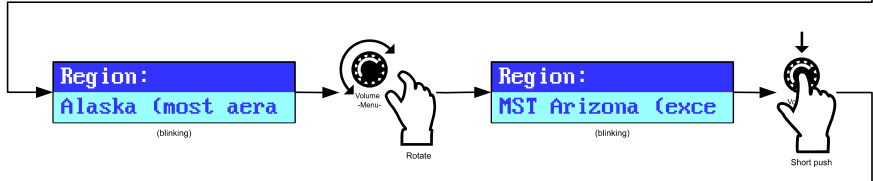

- The player displays **Time zone:** on the first line, and the selected geographical or UTC-relative time zone rule on the second line.

The time zone is set. It is now possible to adjust the date and time. Turn the knob to select the date/time setup sub-menu.

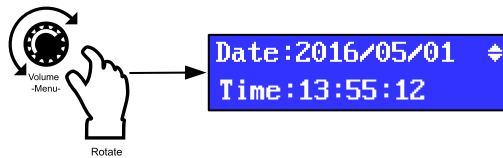

The first line displays the current date of the player (year/month/day). The second line displays the time of the player (hours:minutes:seconds).

2. Date setup:

- Press the knob shortly to edit the date.
- Select and validate a year.
- Select and validate a month in the selected year.
- Select and validate a day in the selected month.

The date is set. It is now possible to adjust the time.

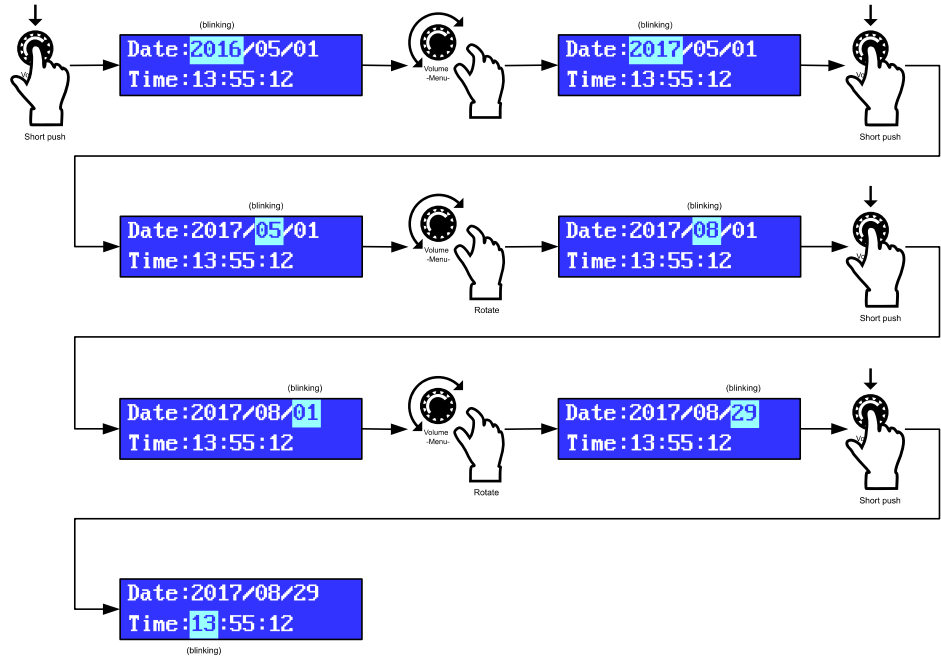

3. Time setup:

- Select and validate an hour.
- Select and validate a minute in the selected hour.
- Select and validate a second in the selected minute.

The time is set. It is now possible to exit the setup menu.

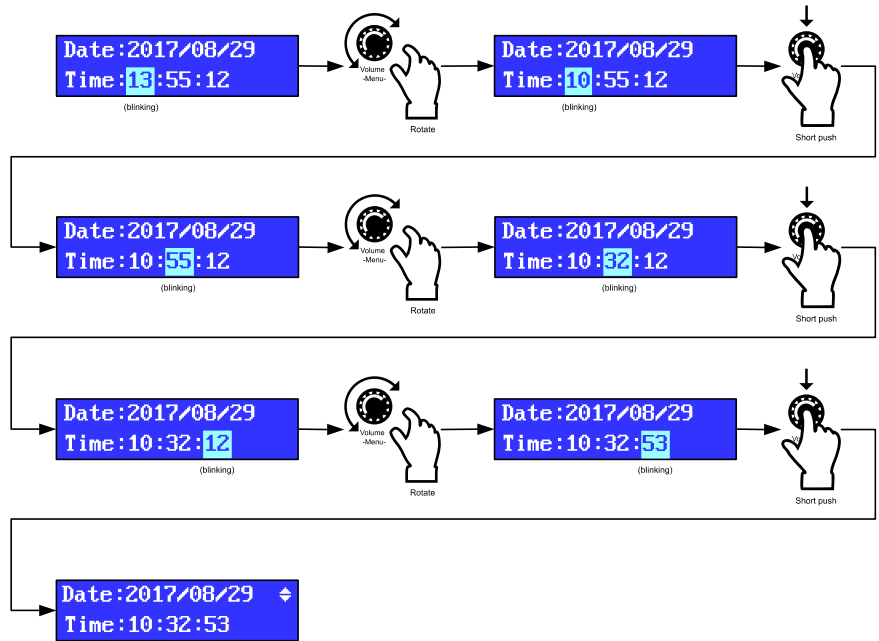

4. Setup menu exit

Select and validate **Return** with the knob.



8 Main Volume Control

8.1 Introduction

The ChronoPlayer has a unique volume setting directly controlling its audio output (RCA / line-level output). This digital setting is applied by the audio converter of the player (DAC). It attenuates the volume over a range of 65 values, from 0 (mute, maximum attenuation level) to 64 (maximum audio level, no attenuation).

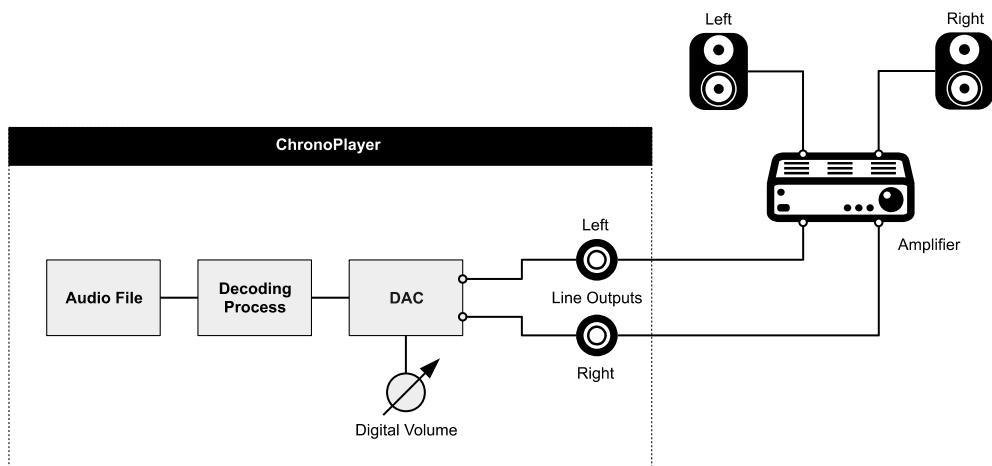

Figure 7: Audio diagram of the ChronoPlayer

Table 6: Volume (dB) against the selected setting value

Value	Volume (dB)	Value	Volume (dB)	Value	Volume (dB)	Value	Volume (dB)
0	MUTE	17	-11,6	34	-5,5	51	-2,0
1	-38,6	18	-11,1	35	-5,3	52	-1,8
2	-31,2	19	-10,6	36	-5,0	53	-1,6
3	-27,3	20	-10,2	37	-4,8	54	-1,5
4	-24,6	21	-9,7	38	-4,6	55	-1,3
5	-22,6	22	-9,3	39	-4,3	56	-1,2
6	-20,9	23	-8,9	40	-4,1	57	-1,0
7	-19,5	24	-8,6	41	-3,9	58	-0,9
8	-18,3	25	-8,2	42	-3,7	59	-0,7
9	-17,2	26	-7,9	43	-3,5	60	-0,6
10	-16,3	27	-7,5	44	-3,3	61	-0,4
11	-15,5	28	-7,2	45	-3,1	62	-0,3
12	-14,7	29	-6,9	46	-2,9	63	-0,1
13	-14,0	30	-6,6	47	-2,7	64	0,0
14	-13,3	31	-6,3	48	-2,5		
15	-12,7	32	-6,1	49	-2,3		
16	-12,1	33	-5,8	50	-2,2		

The following equation expresses the gain value (dB) against the setting value of the selected volume:

$$\text{gain}(\text{val}) = 20 \log_{10} \frac{\max(4 \text{val} - 1, 0)}{255}$$

8.2 Modification of the Main Volume

The volume of the player can be set in different ways. The last applied volume is always retained when the player is switched off, except with the `[V+xx]` and `[V-xx]` tags.

- **With the knob of the player**
Turn the `Volume/-Menu-` knob to change the main volume of the player. (See the section Main Volume Control Using the Knob.)
- **With the infrared remote control**
Use the `Volume+` and `Volume-` buttons of the infrared remote control to change the main volume of the player. (See the appendix Infrared Remote Control.)
- **During the playback of a folder or of a file**
Use the `[V+xx]` and `[V-xx]` tags to change the volume during the playback of a folder or of a file. This modification is relative to the main volume for folders, and to the volume of the folder for files. (See the chapter Control of the ChronoPlayer with the Folders and the Files.)

Note: In this specific case, the relative volume is not be retained if the player is switched off.

- **With a command on the RS-232 serial link**
Use the `03h` command of the RS-232 protocol of the player to change its main volume. This command can be sent from any peripheral equipped with an RS-232 serial link (another ID-AL player, a computer, a PLC, etc.). (See the chapter RS-232 Serial Link Protocol.)
- **With the configuration file**
Define `#VOLUME` in the setup file to change the main volume of the player each time it is powered on. (See the chapter Configuration File.)

Note: This volume setting is always applied upon startup, whatever the previous volume modifications.

9 Configuration File

Some features are only accessible via a configuration file. This file is a text file (raw text, without formatting) that can be created with any simple text editor like “Notepad” from Windows, or similar. This file must be saved with the “ANSI” encoding. Do not use special characters. This configuration file must be named: `config.txt`.

It must be located at the root of the SD card or of the USB flash drive. If this file is missing, the factory settings are applied by default.

The configuration file allows to perform the following settings:

Table 7: Optional parameters in the configuration file

Parameter Definition	Valid Values	Default Value	Description
#ID:xxx	001 to 127	001	Assign a number to the ChronoPlayer to use it with other players through RS-232.
#VOLUME:xx	00 to 64	Last used value	Define the startup volume of the player.
#RS_MONITORING:x	0: No monitoring 1: “Daisy Chain” mode 2: “Monitoring” mode 3: “Advanced Monitoring” mode	0	Configure the monitoring mode of the RS-232 serial link.
#BOOT:xxx	000 to 999	000	Define the folder to play on startup.
#INPUTxx:cmd	xx: 01 to 15 cmd: PLAY STOP NEXT_TRACK PREV_TRACK NEXT_FOLD PREV_FOLD FOLDERyyy - yyy: 000 to 999 VOLUME_PLUS VOLUME_MINUS RSyyy - yyy: 001 to 999	INPUT01:FOLDER001 INPUT02:FOLDER002 INPUT03:FOLDER003 INPUT04:FOLDER004 INPUT05:FOLDER005 INPUT06:FOLDER006 INPUT07:FOLDER007 INPUT08:FOLDER008 INPUT09:FOLDER009 INPUT10:FOLDER010 INPUT11:FOLDER011 INPUT12:FOLDER012 INPUT13:FOLDER013 INPUT14:FOLDER014 INPUT15:FOLDER015	Assign the commands of the input contacts.
#BUTTONx:cmd	x: 1 or 2 cmd: PLAY STOP NEXT_TRACK PREV_TRACK NEXT_FOLD PREV_FOLD FOLDERyyy - yyy: 000 to 999 VOLUME_PLUS VOLUME_MINUS Rsyty - yyy: 001 to 999	BUTTON1:VOLUME_MINUS BUTTON2:VOLUME_PLUS	Assign other commands to the special buttons of the infrared remote control.
#BAUDRATE:xxxxx	9600, 19200, 38400	19200	Define the baud rate of the RS-232 serial port.

Note: Each parameter is defined on a line starting with the # character, followed by the parameter name, followed by a colon :, and at last the associated value. The parameters can be defined in any order. If a parameter is not defined, the player uses its factory setting by default.

9.1 Assign a Device Number - #ID:xxx

It is possible to have several ChronoPlayers in the same installation communicating amongst themselves and with a main device through the RS-232 serial link. In order to do this, a number has to be assigned to each ChronoPlayer among 127 possible IDs, meaning that 127 ChronoPlayers can be used at the same time (see the chapter RS-232 Serial Link Protocol).

Table 8: #ID parameter syntax

Parameter Definition	Description
#ID:xxx	xxx: a number between 001 and 127.

Example

Parameter Definition	Effect of the Defined Parameter
#ID:023	Assign number 23 to the player.

If the line is missing, the factory setting value by default 001 is used, designating the player 001.

Note: Several players can have the same number. All the players with the same number execute the same commands sent through the RS-232 link.

000 is a special case and cannot be used in the configuration file. When the code 000 is sent through the serial link, it means that all the players execute the command sent, whatever the number identifying the player.

9.2 Volume Setting - #VOLUME:xx

It is possible to define the volume to be used on startup. This volume can then be changed with the front knob, with an RS-232 command, or with the infrared remote control.

The volume setting goes from 00 to 64, in 64 steps.

00 is the minimum volume (mute), and 64 is the maximum.

Table 9: #VOLUME parameter syntax

Parameter Definition	Description
#VOLUME:xx	xx: a value between 00 and 64.

Example

Parameter Definition	Effect of the Defined Parameter
#VOLUME:18	The volume is set to 18 on startup.

If the line is missing, the last set value is used

9.3 Configuration of the Baud Rate of the RS-232 Serial Link - #BAUDRATE:xxxxx

By default, the RS-232 serial link is at 19200 bauds in both directions. With this option, this value can be modified.

Table 10: #BAUDRATE parameter syntax

Parameter Definition	Description
#BAUDRATE:xxxx	xxxx: a value among 9600, 19200, 38400.

Example

Parameter Definition	Effect of the Defined Parameter
#BAUDRATE:9600	The player sends and receives at 9600 bauds.

If the line is missing, the factory setting by default is used, i.e. 19200 bauds.

9.4 Monitoring of the Player through the RS-232 Serial Link - #RS_MONITORING:x

The ChronoPlayer has one serial input and one serial output complying with the RS-232 standard. This link can be used to control the player but also to monitor him.

Four configurations are possible to define the kind of outgoing link.

- **Mode 0:** No monitoring. No data is sent by the player.
- **Mode 1:** “Daisy Chain” mode. This mode allows to chain up the players one after another with only one RS-232 link. The Tx serial output of a player is connected to the Rx serial input of the next one and so on. When the first player receives an instruction, this same instruction is sent to its output and so on. **Caution!** When numerous players are chained up, a latency period can exist at the end of the chain.
- **Mode 2:** “Monitoring” mode. In this mode, the player sends some information about its status onto its Tx serial output (see the chapter RS-232 Serial Link Protocol - Transmission Protocol - Monitoring). An external device can therefore receive information to know if the player is playing or stopped. These functions can be used to check the good functioning of the player.
- **Mode 3:** “Advanced monitoring” mode. Besides the functions of the standard monitoring mode, the advanced mode regularly sends information about the player status. A frame is sent or not every 250 ms depending on the status of the player among 3 possibilities:
 1. Stopped - A frame indicating that the player does not play and is waiting for a command is sent.
 2. Playing - A frame indicating that the player is playing a file is sent.
 3. Other - No frame is sent: The player is not available. The memory card is defective or missing, power supply default, the player is out of order, etc.

This mode is used in a context of security message management. A faulty frame reports an error and allows to take corrective action.

Table 11: #RS_MONITORING parameter syntax

Parameter Definition	Description
#RS_MONITORING:x	x: 0: No monitoring. 1: “Daisy Chain” mode. 2: “Monitoring” mode. 3: “Advanced Monitoring” mode.

Example

Parameter Definition	Effect of the Defined Parameter
#RS_MONITORING:1	The player is in “Daisy Chain” mode.

If the line is missing, the factory setting value by default is used, i.e. 0, no monitoring. (For further information regarding the RS-232 protocol, see the chapter RS-232 Serial Link Protocol.)

9.5 Choice of the Folder to Play on Startup - #BOOT:xxx

Sometimes, it can be necessary to define the folder to play on startup. By default, the folder 000 is used as the “AutoPlay” folder.

Table 12: #BOOT parameter syntax

Parameter Definition	Description
#BOOT:xxx	xxx: a number between 000 et 999.

Example

Parameter Definition	Effect of the Defined Parameter
#BOOT:015	The contents of the 015 folder are set to be played on startup.

If the line is missing, the factory setting value by default is used, i.e. 000 for the folder 000.

If the folder does not exist, the player stops and waits for an instruction.

9.6 Assign Specific Commands to the Inputs - #INPUTxx:cmd

By default, each input combination triggers the playback of the corresponding folder. For a better versatility of the player, it is possible to assign other commands to the input combinations.

Table 13: List of the possible commands for #INPUT

Parameter Value	Effect of the Value
PLAY	Play the last played file.
STOP	Stop the current playback.
NEXT_TRACK	Play the next file of the folder being played.
PREV_TRACK	Play the previous file of the folder being played.
NEXT_FOLD	Play the next folder.
PREV_FOLD	Play the previous folder.
VOLUME_PLUS	Increase the volume by one step.
VOLUME_MINUS	Decrease the volume by one step.
FOLDERxxx	Jump to the folder xxx - xxx can be a value between 000 and 999.
RSxxx	Send the line #xxx of the file <code>serial.txt</code> on the RS-232 output (with xxx from 000 to 999).

Table 14: #INPUT parameter syntax

Parameter Definition	Description
#INPUTxx:cmd	xx: an input from 01 to 15 – cmd: an option among the list above.

Caution! Only the first 15 input combinations (using the first 4 inputs) are reconfigurable (see the Table 1: Correlation between the inputs and the folder numbers).

Example of a command keypad using the first 4 inputs

Parameter Definition	Effect of the Defined Parameter
#INPUT01:PREV_TRACK	The first input triggers the playback of the previous file.
#INPUT02:STOP	The second input stops the playback.
#INPUT04:PLAY	The third input launches the playback.
#INPUT08:NEXT_TRACK	The fourth input triggers the playback of the next file.

Example of commands with combinations of input contacts

Parameter Definition	Effect of the Defined Parameter
#INPUT03:RS001	The combination 3 (inputs 1 and 2) sends the frame #001 on the RS-232 link.
#INPUT05:VOLUME_PLUS	The combination 5 (inputs 1 and 3) increments the volume.
#INPUT10:VOLUME_MINUS	The combination 10 (inputs 2 and 4) decrements the volume.
#INPUT14:FOLDER999	The combination 14 (inputs 2, 3, and 4) launches the playback of the folder 999.

9.7 Assign Specific Commands to the Special Buttons of the Infrared Remote Control - #BUTTONx:cmd

The two special buttons of the infrared remote control (see the chapter Infrared Remote Control) are assigned by default to the volume control. With the file `config.txt`, it is possible to assign them other commands.

Table 15: List of the possible commands for #BUTTON

Parameter Value	Effect of the Value
PLAY	Play the last played file.
STOP	Stop the current playback.
NEXT_TRACK	Play the next file of the folder being played.
PREV_TRACK	Play the previous file of the folder being played.
NEXT_FOLD	Play the next folder.
PREV_FOLD	Play the previous folder.
VOLUME_PLUS	Increase the volume by one step.
VOLUME_MINUS	Decrease the volume by one step.
FOLDERxxx	Jump to the folder xxx - xxx can be a value between 000 and 999.
RSxxx	Send the line #xxx of the file <code>serial.txt</code> on the RS-232 output (with xxx from 000 to 999).

Table 16: #BUTTON parameter syntax

Parameter Definition	Description
#BUTTONx:cmd	x: the number of the button 1 or 2 - cmd: an option among the list above.

Example

Parameter Definition	Effect of the Defined Parameter
#BUTTON1:NEXT_TRACK	The command “next file” is assigned to the button 1.
#BUTTON2:STOP	The command “STOP” is assigned to the button 2.

9.8 Example of a Configuration File

Example: config.txt

```
#ID:002
#VOLUME:48
#BAUDRATE:9600
#RS_MONITORING:1
#BOOT:005
#INPUT01:PREV_TRACK
#INPUT02:STOP
#INPUT04:PLAY
#INPUT08:NEXT_TRACK
#BUTTON1:STOP
#BUTTON2:PLAY
```

In the example above, the configuration file `config.txt` assigns the following parameters to the player:

Parameter Definition	Effect of the Defined Parameter
#ID:002	Player ID for the serial link = 002.
#VOLUME:48	Player volume at power on = 48.
#BAUDRATE:9600	Baud rate of the serial link = 9600 bauds.
#RS_MONITORING:1	Monitoring mode = “Daisy Chain”.
#BOOT:005	AutoPlay folder (played on startup) = 005.
#INPUT01:PREV_TRACK	Input combination 1 (input 1) = Previous file.
#INPUT02:STOP	Input combination 2 (input 2) = Stop.
#INPUT04:PLAY	Input combination 4 (input 3) = Play.
#INPUT08:NEXT_TRACK	Input combination 8 (input 4) = Next file.
#BUTTON1:STOP	Button 1 of the infrared remote control = Stop.
#BUTTON2:PLAY	Button 2 of the infrared remote control = Play.

10 RS-232 Serial Link Protocol

The ChronoPlayer can communicate with other devices by receiving instructions onto the Rx input or transmitting data through its Tx output. The player complies with the RS-232 standard.

Table 17: Default settings for the RS-232 link

Baud Rate (bauds)	Start Bit(s)	Data Bit(s)	Parity Bit(s)	Stop Bit(s)	Handshake
19200	1	8	0	1	None

Note: The baud rate is configurable in the settings file of the player `config.txt` (see the chapter Configuration File).

10.1 Reception Protocol

With the input protocol, the player can receive instructions to launch a folder playback or set the volume. Besides, with several players on the same link, the player answers its own number (defined in the file `config.txt`, see the chapter Configuration File) or to a general command.

The reception protocol is based on a 3-byte frame.

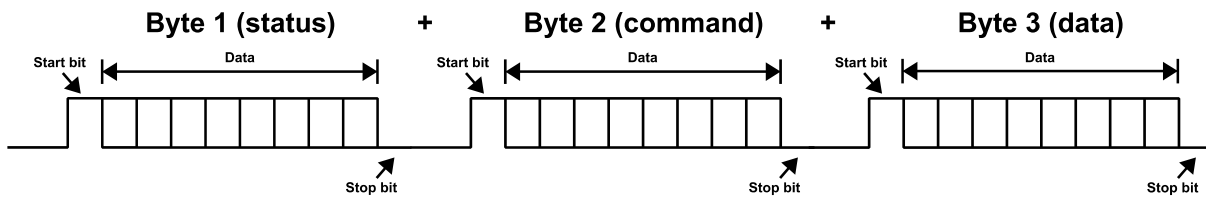

Reminder:

- A byte is composed of 8 bits: b7 b6 b5 b4 b3 b2 b1 b0.
- A byte representation is noted 10000000b in binary, or 80h in hexadecimal.

10.1.1 Byte 1 (Status) 1xxxxxxb

The status byte is a frame synchronization signal. Its 8th bit (b7, most significant bit) is always set to 1. All the other bytes (Command and Data) have this bit set to 0.

b7 = 1: designates a status byte.

b6 - b0: identifier of the player to be addressed from 001 to 127 (0000001b to 1111111b).

- The player address (ID) is 001 by default. It can be modified in the `config.txt` file (see the chapter Configuration File).
- Several players may have the same identification number to create groups.
- The 000 identifier is the broadcast ("general call") address. Its purpose is to address every device connected to the link at the same time (unique command for all the players).

Example of ID address bytes

Value (hexadecimal)	Description
80	Broadcast (“general call”) address for all the players.
81	Player number 001.
9E	Player number 030.
FF	Player number 127.

10.1.2 Byte 2 (Command) 0xxxxxxb + Byte 3 (Data) 0xxxxxxb

The byte 2 is a command and the byte 3 is a data byte that completes the command byte. A command byte is always followed by a data byte. A complete frame is therefore made of 3 bytes.

b7 = 0: designates a command or data byte.

b6, b5, b4: bank selection for the folder jump command.

b3, b2, b1, b0: command code sent to the player.

Table 18: List of the command bytes

Value (hexadecimal)	Description
00	Not used.
01, 11, 21, 31, 41, 51, 61, and 71	“Play folder” command.
02	Playback control command.
03	Volume control command.

- **00h - 0000000b: Not used**
- **01h, 11h, 21h, 31h, 41h, 51h, 61h and 71h – 0xxx0001b: “Play folder” command**
The folder is designated by the bank number and the following data byte.

xxx is the bank number. In order to be able to launch 1000 folders (from 000 to 999), it is necessary to divide this number into several folder ranges (banks) of 128 values.

0xxx0001b: xxx = bank number depending on the folder number

Table 19: List of the byte values for each bank

Value (hexadecimal)	Value (binary)	Bank	Bank Range
01	00000001	0	Folders 000 to 127.
11	00010001	1	Folders 128 to 255.
21	00100001	2	Folders 256 to 383.
31	00110001	3	Folders 384 to 511.
41	01000001	4	Folders 512 to 639.
51	01010001	5	Folders 640 to 767.
61	01100001	6	Folders 768 to 895.
71	01110001	7	Folders 896 to 999.

Note: The values beyond 999 are ignored.

Method of calculation:

- Bank = value in the above table depending on the folder number.
- Value = folder number - (bank number x 128).

Example of a frame launching the folder 278 for the player number 001:

Folder number = 278

- 278 is in bank 2 (from 256 to 383).
- Value = 278 - (2 x 128) = 22 = 16h.

For this example, the complete hexadecimal frame is: 81h 21h 16h.

Example of a frame launching the folder 278 for the player 001

Value (hexadecimal)	Value (binary)	Description
81	10000001	Status byte, player number 001.
21	00100001	Bank 2, "play folder" command.
16	00010110	Value 22 (reference of folder 278 in bank 2).

• **02h - 00000010b: Playback control command**

The transport command is defined by the data byte as follows:

Table 20: Possible values of the data byte

Value (hexadecimal)	Value (binary)	Description
01	00000001	Play.
02	00000010	Stop.
03	00000011	Next file in the current folder.
04	00000100	Previous file in the current folder.
06	00000110	Next folder.
07	00000111	Previous folder.

Note: The other values are ignored.

Example of the complete frame: 81h 02h 01h.

Example of a frame with the "Play" command for the player 001

Value (hexadecimal)	Value (binary)	Description
81	10000001	Status byte, player number 001.
02	00000010	Playback control command.
01	00000001	"Play" command.

• **03h - 00000011b: Volume control command**

The value of the volume is defined by the data byte as follows:

Table 21: Possible values of the data byte – between 0 and 64

Value (hexadecimal)	Value (binary)	Description
00	00000000	Mute, volume at 0.
20	00100000	Half volume, value 32.
40	01000000	Maximum volume, value 64.

Note: The values over 64 are ignored.

Example of the complete frame: 81h 03h 0Eh.

Example of a frame setting the volume at 14 for the player 001

Value (hexadecimal)	Value (binary)	Description
81	10000001	Status byte, player number 001.
03	00000011	Volume control command.
0E	00001110	Volume set at 14.

10.2 Transmission Protocol - Monitoring

The ChronoPlayer can send several kinds of data onto the RS-232 port.

- Custom data sent by the [RSxxx] tags (see the chapter Control of the ChronoPlayer with the Folders and the Files).
- Command data of the player sent in “Daisy Chain” mode.
- Status data of the player sent in the “Monitoring” and “Advanced Monitoring” modes.

To define the kind of data sent through RS-232, 4 monitoring modes exist.

The monitoring mode is defined in the configuration file `config.txt` (see the chapter Configuration File).

The “Daisy Chain”, “Monitoring” and “Advanced Monitoring” modes operate besides the [RSxxx] tags.

- **Mode 0: No monitoring**
Only the data from the [RSxxx] tags is sent onto the Tx output.
- **Mode 1: “Daisy Chain”**
In this mode, any information received on the Rx line is resent out as received onto the line Tx. This mode allows to chain up several players one after another. By connecting the Tx output of the first player to the Rx input of the second player and so on, the information received by the first player on its Rx input is resent to the others players in a chain.

Caution! If numerous players are connected in this way, a slight delay can exist at the end of the chain.

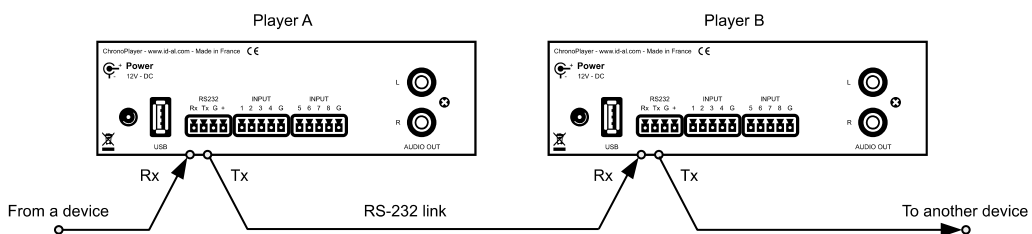

- **Mode 2: “Monitoring”**

In this mode, the player sends information onto the Tx output depending on the actions executed. This mode does not allow to chain up the players. The player allows a PLC, a computer, a security system, to know the status of the player and to make operating tests. In this mode, the player sends its status on each change.

The transmission protocol is made from a 3-byte frame, similar to the reception protocol.

- **Byte 1 (Status)**

b7 = 1: designates the status byte.

b6 - b0: identifier of the sender player from 001 to 120 (0000001b - 11111111b).

The address (ID) of the player is 001 by default, i.e. 81h. Modifiable in the `config.txt` file (see the chapter Configuration File).

- **Byte 2 (Command)**

Unique value: 00h – 00000000b.

- **Byte 3 (Data)**

Table 22: Possible values of the data byte

Value (hexadecimal)	Value (binary)	Description
00	00000000	Player ready. The player reports that it is ready and available on startup.
01	00000001	Not used.
02	00000010	Not used.
03	00000011	Indicates the playback start. This code is sent when the player starts the playback.
04	00000100	Indicates end of playback. The player reports that it has finished the playback of the current file.

The other values are not used.

Example of a process to check the good working of the player when playing an audio file:

Preparation: The player's number is 001.

Create a folder “001” in which is copied an audio file `My file.mp3`.

Launch folder 001 playback (by activating the dry contact 1, or with the sending of an RS-232 command).

- When the playback starts, the player sends a frame indicating the beginning of the playback: 81h 00h 03h.
- At the end of the playback, is the player sends a frame indicating the end of the playback: 81h 00h 04h.

- **Mode 3: “Advanced Monitoring”**

Besides the functions of the standard monitoring mode, the advanced mode regularly sends information about the player status. A frame is sent or not every 250 ms depending on the status of the player among 3 possibilities:

Table 23: Possible values of the data byte

Value (hexadecimal)	Value (binary)	Description
No frame sent	No frame sent	The player is unavailable because of some issue.
01	00000001	The player is not playing, and is waiting for an instruction.
02	00000010	The player is playing a file.

This mode is used in a context of security message management. A faulty frame reports an error and allows to take corrective action.

11 Firmware Update

The logic and functionality of the player are defined with an internal program called “firmware”. This program may evolve to bring new features, to change the behavior of the player, or to fix issues. The firmware can be updated or replaced by following these instructions:

1. On the www.id-al.com website, download the firmware from the support page of the ChronoPlayer.
2. Make sure that the SD card is properly formatted using FAT32 (USB flash drives are not supported).
3. Copy the file `CHRONO.bin` at the root of the SD card.
4. Eject the SD card with the ejection process of your operating system.
5. Switch off the player.
6. Insert the SD card in the player and switch it on. Wait until the activity LED of the player turns green.
7. At this time, the firmware update is over. The player can be switched off and the SD card removed.

Note: The firmware update has to be done with an SD memory card. The update is not supported with a USB flash drive.

Appendix A Characteristics

A.I Interfacing and Connectivity

- LED status indicator
- Backlit LCD display – 2x16 characters
- Clickable knob (Volume/-Menu-)
- Infrared sensor - Protocol SONY SIRC 12 bits modulated at 38 kHz
- USB Host 2.0 Full Speed (12 Mb/s), standard “mass storage” driver, type A connector
- SD/SDHC Card slot
- RS-232 serial link – 9600, 19200, or 38400 bauds 8N1 on 3.81mm pluggable terminal block
- 8 configurable opto-isolated inputs on 3.81mm pluggable terminal block
- A line-level 0dB stereo audio output on a standard RCA connector
- External DC power supply connector – Ø 2.1 mm / 5.5 mm

A.II Audio File Formats Supported

- MP3 (.mp3): mono/stereo (MPEG layer 3), 16 bits, 44.1 kHz, from 32 kbit/s to 320 kbit/s, CBR (Constant Bit Rate) or VBR (Variable Bit Rate) files
- WAV (.wav): mono/stereo, 16 bits, 44.1 kHz (Broadcast Wave Format not supported*)

A.III Other File Formats Supported

- Timestamped programming file (scheduler.tm2) - Scheduler TM2 (.tm2) format
- Configuration file (config.txt) – raw text format (.txt)
- Serial codes file (serial.txt) – raw text format (.txt)

A.IV Storage Devices

- Accepts SD cards – 64 MB minimum to 4 GB maximum - Formatted using FAT16 or FAT32
- Accepts SDHC cards – 4 GB minimum - Formatted using FAT32
- Accepts USB flash drives formatted using FAT16 or FAT32
- Supports long filenames limited to 63 characters maximum including extension
- Accepts 1000 folders maximum at the root, containing up to 999 files each

A.V Built-in Clock

- Maximum clock drift:
 - From 0 to +50 °C: 3.8 ppm – 120 seconds per year
 - From +50 to +60 °C: 5.0 ppm – 156 seconds per year
 - Aging: ±3 ppm/year
- Timekeeping when the player is not powered: up to 2 months

A.VI Power Supply

- Player power supply input:
 - Nominal voltage: 12 V DC
 - Power supply range: 10 V to 15 V DC
- Supplied mains adapter input:
 - Voltage: 100 V to 240 V.
 - Frequency: 50 Hz to 60 Hz.

A.VII Consumption (12 V supplied)

- During playback: 80 mA
- When stopped: 70 mA

A.VIII Temperatures

- Operating ambient temperature: from 0 to +60 °C
- Storage temperature: from -20 to +60 °C

A.IX Size

- Width: 143 mm - (1/3 of a rack)
- Height: 44 mm
- Depth (with terminal block connectors): 100 mm

A.X Weight

- 200 g (with the pluggable terminal blocks)

***Note:** Various professional software for composition and editing create Broadcast Wave Format files instead of standard WAV files. The ChronoPlayer is not compatible with this file type. Please use standard WAV files to ensure a perfect compatibility between your audio files and the specifications of the player.

Appendix B Infrared Remote Control

The ChronoPlayer can be controlled with an infrared remote control thanks to an infrared sensor fitted at the front of the player.

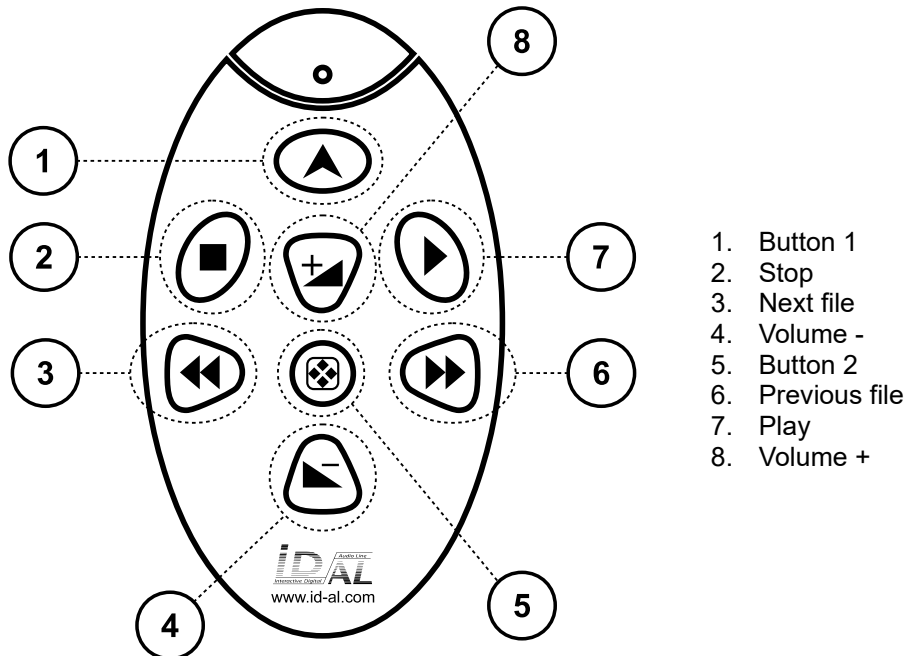

This remote control supports:

- the transport commands: Play / Stop / Next file / Previous file,
- the volume commands: increase or decrease the volume,
- triggering keys: configurable buttons (see the chapter Configuration File).

Appendix C Built-in Clock

C.I Principle

The built-in clock of the ChronoPlayer, called RTC (Real Time Clock), is accurate and standalone. The date and time of the player are always kept up-to-date, whether the player is powered or not, thanks to a built-in battery. The start and end of daylight saving time are automatically handled by a management of the time zones, according to the country* where the player is located. In order to operate properly, the Scheduler feature requires the built-in clock to be adjusted. (See the chapter Control of the ChronoPlayer with a Timestamped Programming (Scheduler).)

***Note:** Except for Iran and Morocco, all the global time zone rules are supported. For some areas of Brazil, the rules of the player will not be correct for the years 2023, 2026, 2034, and 2037. Nevertheless, the player remains usable in these areas with UTC rules, which have to be modified manually when necessary.

C.II Built-in Clock Setup

The setup parameters of the built-in clock are the following:

- Time Zone:
This parameter selects either a geographical rule specific to a world area, country, and region, or a constant offset relative to the Coordinated Universal Time (UTC). The geographical rules automatically change the UTC-relative offset during the year to manage daylight saving time.
 - The geographical rules are selected with the following steps:
 1. Select a World Area among the following list: Africa, Americas, Antarctic, Arctic Ocean, Asia, Atlantic Ocean, Australia, Europe, Indian Ocean, Pacific Ocean.
 2. Select a country relative to the world area. The listed countries depend on the chosen world area.
 3. Select a region relative to the chosen country. This parameter only exists if the chosen country has several regional rules.
 - Constant UTC-relative offsets can be selected from UTC-12:00 to UTC+14:00.
- The current Date of the player, which is composed of the following items:
 - The year, between 2016 and 2037.
 - The month of the year.
 - The day of the month (the month and leap years are taken into account to determine the number of days in a month).

Note: The setup of the date uses the following international writing convention: `YYYY/MM/DD`, with `YYYY` the year, `MM` the month, and `DD` the day of the month, e.g. `2016/01/29` for January 29, 2016.

- The current Time of the player, which is composed of the following items:
 - The hours, in the 24-hour format.
 - The minutes.
 - The seconds. (The leap seconds are not managed.)

Note: The setup of the time uses the following international writing convention: `HH:MM:SS`, with `HH` the hours, `MM` the minutes, and `SS` the seconds, e.g. `15:30:52` for 3 hours in the afternoon, 30 minutes and 52 seconds.

C.III Clock Setup

Various scenarios require that the clock of the player be adjusted:

- On the first startup of the player:
When the player is switched on for the first time, it is required to immediately adjust the clock (time zone, date, and time). This setup of the clock is quite the same as the one described in the section Setup of the Player Clock Parameters.
- When the built-in clock could no longer be maintained when powered off:
The built-in clock is battery-backed by the player during several weeks when powered off. Nevertheless, when the battery is too discharged, the date and time of the clock are lost and have to be adjusted again.

Note: The time zone setting is not affected by the built-in clock (RTC) and is retained even if the battery runs flat. In this case, it is not necessary to set this parameter again.

This adjustment is quite the same as the one described in the section Setup of the Player Clock Parameters.

- After a firmware update:
The firmware update resets all the parameters of the player, time zone included. Therefore, following a firmware update, the player prompts the user to set the time zone on each startup until the operation has been performed. On the other hand, the date and time are not parameters, but values that evolve according to the time. These values are therefore not affected by firmware updates. A player having its date and time adjusted but not its time zone applies the UTC time by default.
- When the parameters of the clock have to be modified:
If an already configured player is moved to another time zone, or in case of a clock adjustment, or in case of a wrong adjustment of the date and time, the settings of the clock must be adjusted accordingly. These operations are described in the section Setup of the Player Clock Parameters.

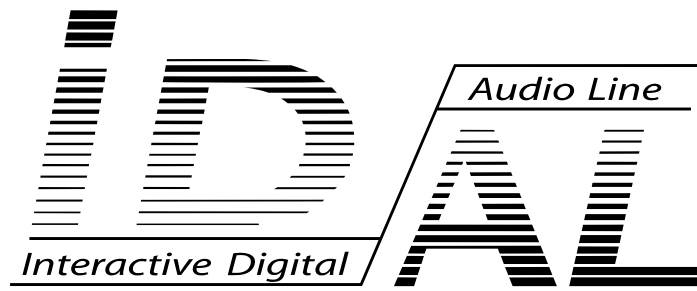

by



For more information
visit our website
www.id-al.com