

Waves System Event Video Player EVP380

Quick Start Guide V1.2

1 Introduction

This guide explains how to quickly start up the EVP380 for a first use. **For further information and help on this product, see the support page of the EVP380 on www.waves-system.com.**

The EVP380 is a standalone and interactive player that allows the playback of show control, video 4K HDR UHD and HTML5/JavaScript contents. It is capable of playing SC3 show control files synchronously with video, picture, or audio files. These files can be stored in an internal memory, on a microSD card, or on a USB flash drive. The playback can be programmed to start automatically, to follow a schedule, or to respond to external events (infrared remote control, input contacts, RS-232, TCP/IP, JavaScript, REST, DMX512, or Art-Net).

2 Hardware Description

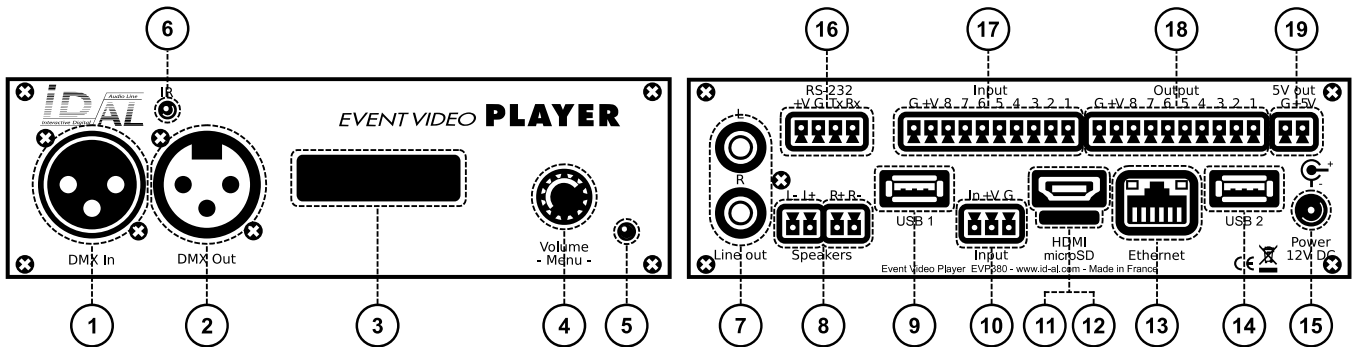

- 1 Isolated DMX512 input with built-in switchable 120 Ω termination and switchable pass-through to the DMX512 output, male XLR3
- 2 Isolated DMX512 output, female XLR3
- 3 Backlit LCD display
- 4 Clickable knob (volume and LCD menu)
- 5 Status LED
- 6 Infrared sensor
- 7 0 dBu line-level stereo audio output, RCA
- 8 Amplified stereo speaker output, pluggable terminal blocks
- 9 USB Host 2.0 for USB flash drive and touch screen, type-A
- 10 Standalone opto-isolated input contact and power supply pass-through, pluggable terminal block
- 11 HDMI audio/video output, type-A
- 12 microSD card slot
- 13 10/100 Mbps Ethernet, RJ45
- 14 USB Host 2.0 for USB flash drive and touch screen , type-A
- 15 External DC power supply chassis socket
- 16 RS-232 serial link and power supply pass-through, pluggable terminal block
- 17 8 combined opto-isolated input contacts and power supply pass-through, pluggable terminal block
- 18 8 MOSFET outputs and power supply pass-through, pluggable terminal block
- 19 5 V DC output, pluggable terminal block



Button	Description
	Short press: standby/wake-up. Long press: power off / restart.
	Mute/unmute.
	Skip 10 seconds backward/forward.
	Play/pause.
	Stop Playback.
Red Green Yellow Blue A B	Programmable buttons: by default, play folder 1 to 6, respectively.
	Toggle on-screen information display.
	Exit.
	In menu context: up/down. In playback context: next/previous folder.
	In menu context: left/right. In playback context: previous/next file.
	In menu context: validate selection. In playback context: toggle on-screen information display.
	Toggle on-screen menu display.
	Back.
VOL+ VOL-	Increase/decrease the volume.
	When selecting a value, typically with a slider control, skip many values.
0 1 2 3 4 5 6 7 8 9	In menu context: digit characters. In playback context: play folder 0 to 9.
	Dot character.
	Erase previous character.

3 Connecting the Hardware Interfaces

First, make sure that the player is off (mains adapter unplugged). Then, connect the hardware interfaces according to the needs:

Interface	Usage
microSD and USB	If needed, prepare a storage device, then plug it into the player. See 5 Programming the Player .
Video output	Compatible with a wide range of HDMI displays.
Audio outputs	Connect non-amplified speakers to the amplified speaker output, or amplified speakers to the line-level audio output, or use the HDMI audio.
Ethernet network	NTP player time synchronization, FTP access to the player storage, media stream playback, playback synchronization between players, TCP/IP or Art-Net or Web API player control, Art-Net preparation and recording of Show Control content, display of web content hosted remotely, configuration / content update / control on the local network (remote administration) or through Internet (Wavespark), PJLink wake-up and standby video projector.
Power supply outputs	On the pluggable terminal blocks: power supply for accessories requiring little power.
RS-232 serial link	Control of other devices, such as video projectors or PLCs, or control of the player from another device using a dedicated protocol.
DMX512 input and output	Connect them respectively to a DMX512 controller, such as a lighting console, and to DMX512 receivers, such as dimmers or moving lights.
Input and output contacts	Connect them as explained in the following sections.

3.1 Input Contacts

The 1 + 8 input contacts can be configured to trigger various actions, such as playback control, standby, wake-up, or sending a serial frame. Devices behaving like switches can be connected between these inputs and the ground of the player (e.g.: push-button, presence sensor, relay, PLC, SensoPad, IRPad). Active devices can use the power supply pass-through. Each input can be configured as normally open or closed.

The 1st to 8th combined inputs are respectively associated with the following values when active: 1, 2, 4, 8, 16, 32, 64, 128. The action taken for these inputs depends on their combination, defined as the sum of the values of all the active inputs, which is simply the value of an input if it is the only one active. If more than 8 triggering devices are needed, the Waves System Ext15In board or a diode-based circuit can be used to get more than 8 combinations from these devices.

By default, the standalone input plays folder 1, and the 8 combined inputs play the folder numbered with the active combination.

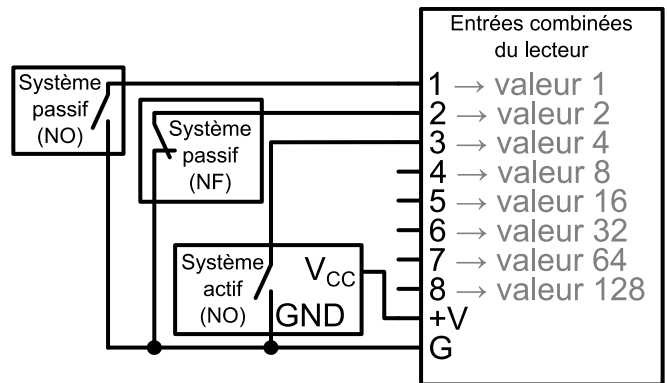

3.2 Output Contacts

The 8 outputs behave like normally-open switches between each contact and the ground of the player (up to 500 mA per output). They can be used to operate devices such as power relays, motor controllers, lights, or players.

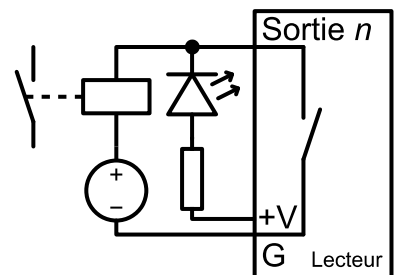

4 Starting the Player

- After having connected all the required interfaces, turn the player on by plugging the mains adapter. The status LED should quickly get red, which signals that the player is booting.
- Wait for the status LED to turn green, which indicates that the player is ready.
- Press on the remote control to display the on-screen menu, then configure the player according to the desired settings such as system language, network, date and time, security of the access of the FTP server and the remote administration, etc.
- When the player is connected to a local network, the configuration is possible with an internet browser. To do this, enter `http://` followed by the IPV4 address or the mDNS name of the player in the address bar (see [7 Identify the Player on the Ethernet Network](#)). Once connected to the remote administration of the player, enter `admin` as identifier and `password` as password.
- In order to make sure that the player benefits from the latest features and improvements, it is possible to perform a firmware update from `System settings` → `System update`. If an Internet connection is available, it is recommended to follow the automatic procedure using `Check for update`.

5 Programming the Player

5.1 General Rules

The player is programmed by organizing media files and other files in a specific way (see the example opposite) on a storage device (microSD card, USB flash drive, or internal storage). The external storage devices must initially be formatted using one of the supported file systems (FAT32 or exFAT are recommended), after which it can be filled using a computer then plugged into the player, or first plugged into the player then filled through the remote administration of the player (default username and password: `admin` and `password`). (see 7 Identify the Player on the Ethernet Network).

- `SYSTEM` folder: contains configuration files and other files used by the system.
- Playback folders, numbered from `0` to `999`: contain the usual multimedia and show control files (MP4, MKV, MOV, SC3, STREAM, WAV, MP3, M4A, JPG, PNG, etc.). These folders are prefixed or not with zeros. They are used as an identifier for commands. (Sub-folders excluded)
- `SYNCHRO` folder: contains the multimedia files to be played when receiving a synchronized playback request. These files must be numbered. (Sub-folders excluded)
- `WWW` folder: contains the HTML5/JavaScript pages and all files necessary for their operation.

The playback folders can have an arbitrary working name after their number. Various directives, called tags, can be added between square brackets. These tags can be used to control the playback, the volume, and the output contacts, to send serial frames, to block commands from a configurable list of sources, or any controls available with tags. For the complete tag specification, see the user guide.

The multimedia files inside the playback folders can also have tags. They can be numbered to ease sorting in sequential playback mode.

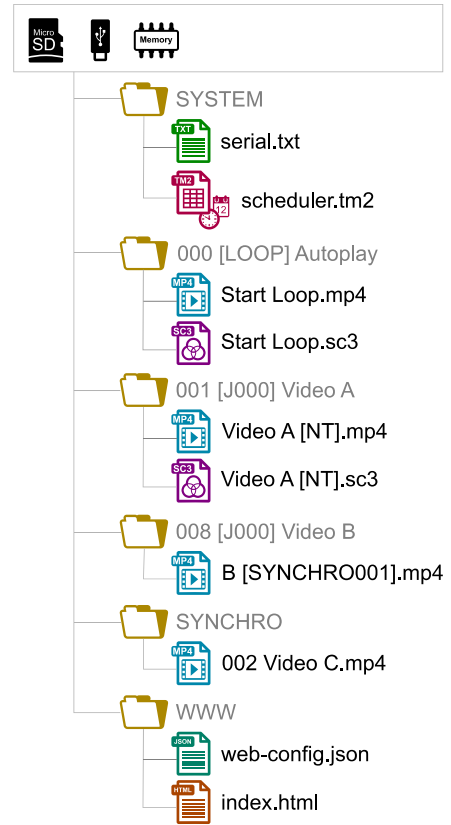

5.2 Show Control Playback

For the standalone control of a show (i.e. to control the output contacts, to send serial frames, and to send packets on the DMX512 output or through Art-Net during a time frame), a file with the extension `.sc3` containing show data must be placed into a playback folder like a regular media file. If there is a media file in this folder with the same name apart from the extension, then both files are played synchronously. Otherwise, the `.sc3` file is played alone. This file can be generated either with the Show Control Editor software (downloadable from www.waves-system.com) on a computer, or by recording a DMX512 or Art-Net show directly from the player. See 6 Show Control Subsystem.

5.3 HTML5/JavaScript Content

Execution of HTML5/JavaScript code and display of overlaid web pages on the video playback is provided by an embedded web server. An additional JavaScript API allows you to control the playback from HTML5/JavaScript content.

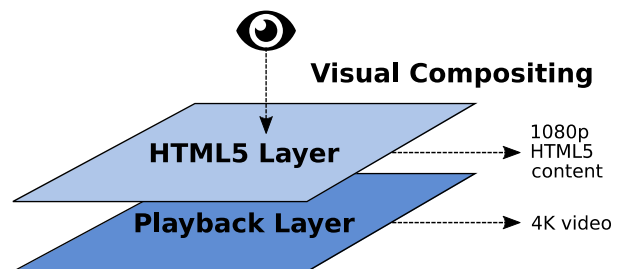
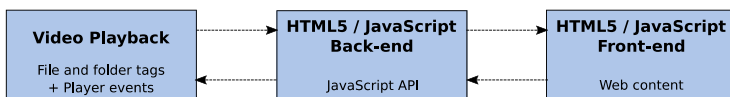

The creation and implementation of web content is done in 3 steps:

Step 1	Step 2	Step 3
Create web content Create HTML5 / JavaScript web pages (place the local content to <code>www</code> folder). If necessary, use the JavaScript API to control the player from web pages.	Indexed web content Add the URLs of web pages by using the dedicated tool from the remote administration of the player or by editing the <code>web-config.json</code> file.	Add file tags Add to folders or files the dedicated tags to show or hide web content (<code>[WEBS x]</code> , <code>[WEBE x]</code> , <code>[WEBS OFF]</code> , <code>[WEBE OFF]</code>)

For more information on this topic, see the user guide.

5.4 Streaming

In order to play a video or audio stream, a file with the extension `.stream` must be placed into a playback folder like a regular media file. This file describes the stream and gives its network address. See the user guide for details.

5.5 Scheduler

In order to schedule commands, a file named `scheduler.tm2` must be generated on a computer thanks to the Scheduler software (downloadable from www.waves-system.com), then placed into the `SYSTEM` folder.

5.6 Serial Frames

The serial frames that the system needs to send must be listed in a file named `serial.txt`, which can be created with a raw text editor on a computer according to a specific syntax, then placed into the `SYSTEM` folder. This file can also be created and edited using the player remote administration (see 4 Starting the Player). The transmission of the serial frames can be programmed using folder or file tags, or `.sc3` files, or a direct command order. See the user guide for details.

5.7 Further Configurations

Various aspects of the playback and of the usage scenario can be configured in the on-screen menu (☰) or in the remote administration, under `Playback engine settings` and `Scenario settings`, respectively. Contrary to all the other settings, the `Scenario settings` are linked to the specific use case programmed on the storage device. That's why they are saved by the player in `SYSTEM\scenario-config.json` on the current storage device in order to make them easily portable to other players.

6 Show Control Subsystem

The show control subsystem of the player can receive packets from the DMX512 input and Art-Net universes. These packets can:

- control the playback, the volume, and the output contacts, and send serial frames, according to the specified DMX mapping (see the user guide),
- be forwarded to the DMX512 output,
- be recorded in `.sc3` files using various recording start and stop conditions, including a configurable recording control channel with a threshold.

The packets contained in the `.sc3` files (see Show Control Playback) can:

- control the output contacts and send serial frames,
- be forwarded to the DMX512 output or through Art-Net up to 64 universes.

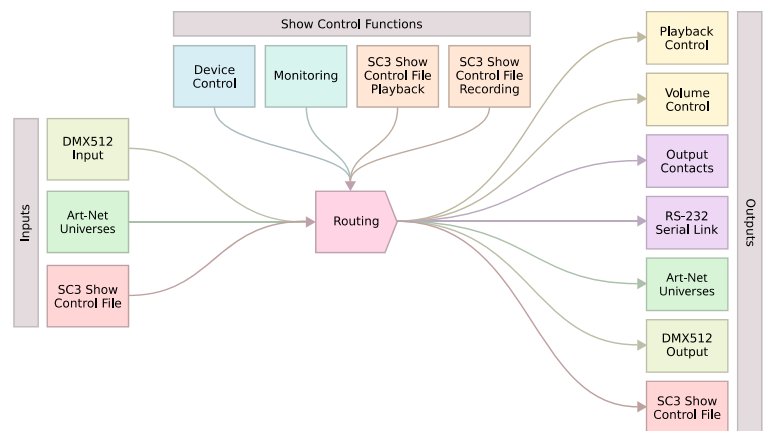

Besides the regular playback and recording modes, the show control subsystem offers a monitoring mode that can be used in a preparatory stage to try out the DMX512 or Art-Net sources without changing the production settings. The show control modes can be enabled and configured fully from the on-screen menu (☰ → under `Show control`) or partially in the remote administration (`System settings` → `Show control`).

7 Identify the Player on the Ethernet Network

The IP address of the player is indicated on the front panel LCD display thanks to the clickable knob, or in the on-screen menu (☰ → `System settings` → `Network` → `Connected`) thanks to the infrared remote control. It is also possible to identify the player on a network using its mDNS name `EVP380-sernum`, `sernum` being the serial number indicated under `About` in the on-screen menu (☰).

8 Further Steps

Go to the support page of the EVP380 on www.waves-system.com for the advanced features, further information, documentation, firmware, software, and examples.